



Product Information  
Version 1.0

## **ZEISS Colibri**

Your Flexible and Efficient LED Light Source  
for Gentle Fluorescence Imaging



## Your Flexible and Efficient LED Light Source for Gentle Fluorescence Imaging

- › **In Brief**
- › The Advantages
- › The Applications
- › The System
- › Technology and Details
- › Service

Your tasks in Life Sciences often require specific fluorescent labels. These labels need to be excited by exactly the right wavelength. Or multiple wavelengths. Depending on the type of your experiments you also need stable and robust illumination to obtain reproducible data. Or you want to perform ultrafast ratiometric live cell imaging. Your Colibri LED light source gives you all of this in a very compact housing, directly coupled to your microscope. You get full intensity, adjustment free and without an aging light guide. The light emitting diodes (LEDs) are ideal for gentle live cell imaging: they only emit light within a narrow part of the spectrum and have no unwanted, cell-damaging UV leakage. They can be turned on and off in microseconds. This makes your imaging fast, and saves lamp life, as they are switched off instantly, whenever acquisition is paused. Also, every single LED of your Colibri can easily be attenuated to exactly match the excitation dose to even your most sensitive samples. What's more: you can also use your Colibri with a multi bandpass filter to use any manual microscope for automated multichannel imaging with the powerful ZEN imaging software from ZEISS.



*HeLa-cell with EB3 labelled in cyan and histones labelled in red.*

# Simpler. More Intelligent. More Integrated.

- › In Brief
- › **The Advantages**
- › The Applications
- › The System
- › Technology and Details
- › Service

## Your Flexible Light Source

Your Colibri light source can house LEDs with a broad variety of wavelengths and intensities. Choose the ideal configuration to exactly match your applications and budget. All LEDs were specifically selected to deliver exactly the right wavelength and intensity for all your experiments in Life Sciences research. You always get enough excitation power to shorten exposure times and to speed up your image acquisition, if necessary.

## An Efficient Workhorse

LEDs convert electrical power into light more efficiently than other light sources. With Colibri you make your imaging experiments more efficient and reproducible, as control over excitation intensity is precise and very stable. Coupling directly to your stand does not waste energy in light guides and gives best intensity. You control Colibri with the familiar ZEN imaging software, your control panel or the TFT of your ZEISS microscope. You always get easy and fast access to your fluorescence excitation.

## For Gentle Live Cell Imaging

LEDs can be attenuated easily and do not emit unwanted heat or cell-damaging UV light. Your Colibri houses specially designed and selected filters that are optimized to excite all common dyes and fluorescent proteins with highest accuracy. Your sample is only exposed to the radiation that is needed to excite the fluorescent label. Use ZEN imaging software and hardware triggers to control excitation intensity and wavelength with microsecond precision, perfectly synchronized with your image acquisition. Your sensitive sample is only exposed to light, when a frame is acquired.



Microtubules labelled with GFP

# Your Insight into the Technology Behind It

- › In Brief
- › **The Advantages**
- › The Applications
- › The System
- › Technology and Details
- › Service

## ZEISS Colibri 5: Your Affordable LED Light Source for High End Imaging

- **Broad spectrum excitation:** Four illumination channels cover the most important dyes, fluorescent proteins and probes
- **Matched filters:** The excitation filters in Colibri 5 have been specifically designed to precisely match the LEDs' emission spectra. This avoids cross-talk between the different channels and greatly increases excitation efficiency of selected dyes. For highest imaging efficiency single and multiband path LED filters sets are available. Precise matching of LEDs with filters results in minimal crosstalk and maximum excitation and emission efficiency.
- **High efficiency:** Maximize light transfer efficiency, thanks to direct coupling and an optical design with reduced optical elements.
- **Compact housing, low noise:** The housing of Colibri 5 is optimized to consume as little space as possible. Colibri 5 will not disturb your work environment with a noisy fan or vibrations.
- **Linearized LEDs:** Be sure that any value you adjust your LED to, corresponds exactly to the power, that the LED emits. This means that e.g. a 50 % reduction will result in precisely half the power than running the LED at 100 %.
- **Flexible and precise excitation control:** Directly control Colibri 5 through control panel and microscope TFT. Using the camera trigger for control you get fastest image acquisition. Precise hardware synchronisation through TTL triggering, perfect integration into ZEN imaging experiments with tightest synchronization to use all the excitation light that reaches the sample to generate the image.
- **Precise power output thanks to On-Chip temperature sensing:** Each LED emitter is equipped with an on-board temperature sensor to precisely measure the current temperature in the millisecond range



# Your Insight into the Technology Behind It

- › In Brief
- › **The Advantages**
- › The Applications
- › The System
- › Technology and Details
- › Service

With Colibri 5, you can use up to four different LEDs for fluorescence excitation of your sample. All LEDs come with individual excitation filters. Available excitation lines of Colibri 5 are exactly centered around the most common dyes and fluorescent proteins.

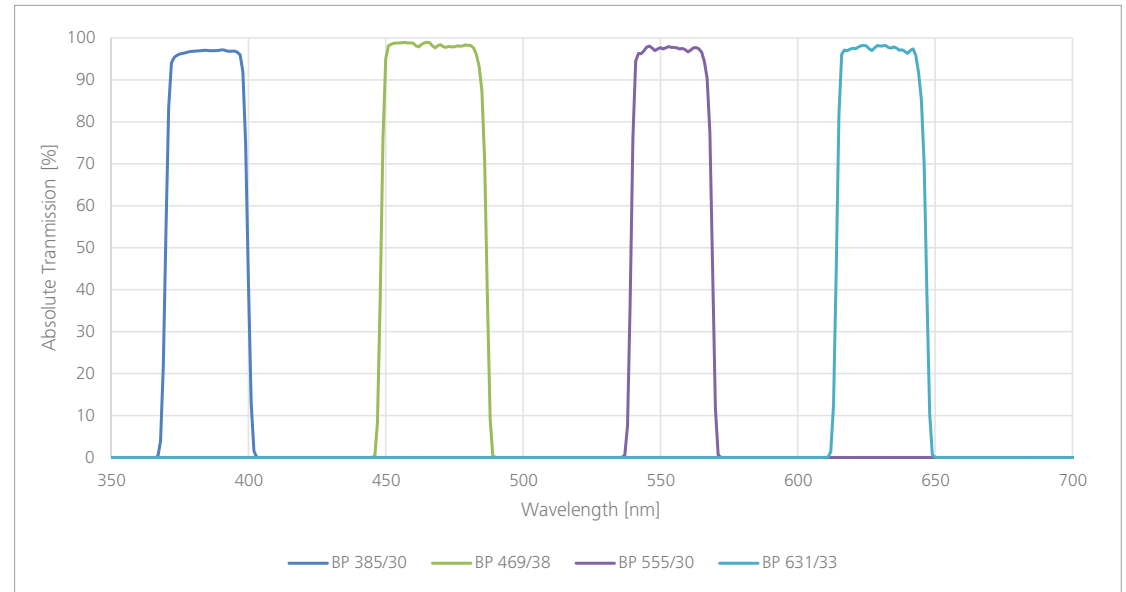

Built-in excitation filter of ZEISS Colibri 5

## Available Excitation Bands for ZEISS Colibri 5

Line	Wavelength / Bandwidth	Recommended Dye (Examples)
UV	385/30 nm	DAPI, Hoechst 33342, Hoechst 33258, Alexa Fluor 350, Alexa Fluor 405, Indo-1, eBFP/BFP, eGFP (wt), True Blue
B	469/38 nm	FM1-43, Cy2, eGFP, NBD, MitoTracker Green, Alexa Fluor 488, BCECF, Calcein, DiO SNAFL, YO-Pro-1, Nissl, LysoSensor Green, mHoneydew, FITC/Fluorescein, Kaede (green/red), PerCP, YoYo-1, FuraRed
G	555/30 nm	TRITC, 7-AAD, Cy3, tdTomato, Alexa Fluor 546, Alexa Fluor 555, DsRed, mOrange, TagRFP, SNARF, DyLight 549, Spectrum Orange
R	631/33 nm	Alexa Fluor 633, Alexa Fluor 647, Cy5, DRAQ5, ToTo-3, ATTO-655, MitoTracker DeepRed, APC, ATTO-647N

# Your Insight into the Technology Behind It

- › In Brief
- › **The Advantages**
- › The Applications
- › The System
- › Technology and Details
- › Service

## ZEISS Colibri 7: Your Flexible and Fast LED Light Source for Gentle Live Cell Imaging

- **Very broad spectrum excitation:** Up to 7 illumination channels cover all important dyes, fluorescent proteins and probes.
- **On-Chip temperature sensing:** Each LED emitter is equipped with an on-board temperature sensor to precisely measure the current temperature in the millisecond range.
- **Closed-loop temperature control:** A special, vibration-decoupled fan in combination with a special on-chip cooling design. The fan is controlled via direct feedback from the LEDs.
- **Long-term power stabilization:** While booting, maximum power is measured and compared to a factory value. LED power is measured and compared to internal references to allow stable and constant output power over the entire lifetime of each LED.
- **Real-time control:** As long as only one LED is turned on, the photodiode acts as a closed-loop power stabilization in the  $\mu\text{s}$  range. It is capable of controlling the power of the active LED even during the exposure time of an image. This guarantees a stable light output even if the LED is used in short millisecond ranging exposures.
- **High efficiency coupling of LEDs to sample plane:** direct coupling, optical design with reduced optical elements.
- **All LEDs can be used simultaneously without restriction:** Should your application require it, you can switch on as many LEDs as needed (or even all of them) at once.

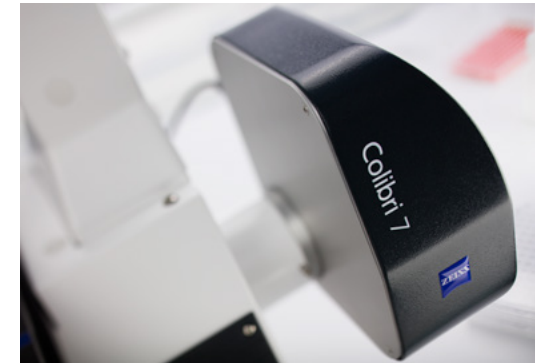

# Your Insight into the Technology Behind It

- › In Brief
- › **The Advantages**
- › The Applications
- › The System
- › Technology and Details
- › Service

With Colibri 7, you use up to six different LEDs to generate up to seven fluorescence excitation lines for your sample. All LEDs besides the Green/Yellow line [G/Y] come with individual excitation filters. The [G/Y] line uses a lime LED (567 / 100 nm) and a motorized filter changer to emit green (555 nm) or yellow (590 nm) light on demand.

Available excitation lines of Colibri 7 are exactly centered around the common dyes and fluorescent proteins.

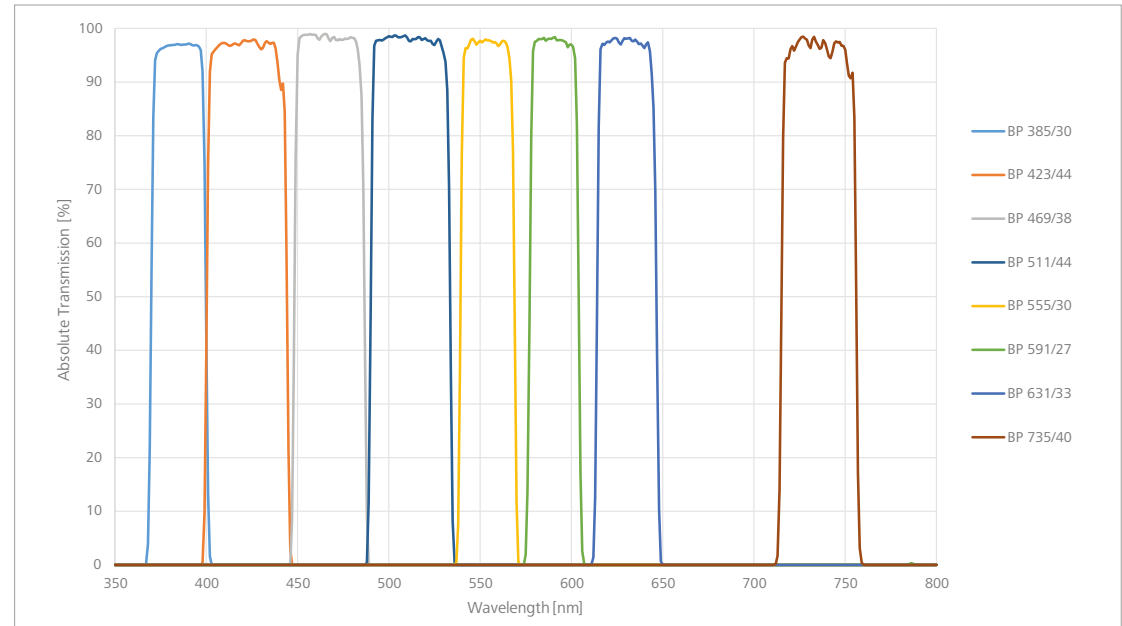

Built-in excitation filter of ZEISS Colibri 7

## Available Excitation Bands for ZEISS Colibri 7

Line	Wavelength / Bandwidth	Recommended Dye (Examples)
UV	385/30 nm	DAPI, Hoechst 33342, Hoechst 33258, Alexa Fluor 350, Alexa Fluor 405, Indo-1, eBFP/BFP, eGFP (wt), True Blue
V	423/44 nm	Pacific Blue, Lucifer Yellow, Alexa Fluor 433, eCFP, Cerulean
B	469/38 nm	FM1-43, Cy2, eGFP, NBD, MitoTracker Green, Alexa Fluor 488, BCECF, Calcein, DiO SNAFL, YO-Pro-1, Nissl, LysoSensor Green, mHoneydew, FITC/Fluorescein, Kaede (green/red), PerCP, YoYo-1, FuraRed
C	511/44 nm	Rhodamine 123, Fluo-4, Oregon Green BAPTA, Sytox Green, eYFP, FM4-64, Eosin/HE, Acridine Orange, JC1, Bodipy FL, Propidium Iodide, Spectrum Green, Calcium Green
G	555/30 nm	TRITC, 7-AAD, Cy3, tdTomato, Alexa Fluor 546, Alexa Fluor 555, DsRed, mOrange, TagRFP, SNARF, DyLight 549, Spectrum Orange
Y	590/27 nm	MitoTracker RED FM/CMXRos, txRed, mCherry, mRFP1, Cy3.5, Rhodamine B, Alexa Fluor 568, DyLight 594, Alexa Fluor 594, Bodipy TR
R	631/33 nm	Alexa Fluor 633, Alexa Fluor 647, Cy5, DRAQ5, ToTo-3, ATTO-655, MitoTracker DeepRed, APC, ATTO-647N
FR	735/40 nm	Alexa Fluor 750, Alexa Fluor 790, Cy7, Cy7.5

# Your Insight into the Technology Behind It

- › In Brief
- › **The Advantages**
- › The Applications
- › The System
- › Technology and Details
- › Service

## Power Calibration during Boot Process:

- Warm-up of each LED
- Ramp-up of each LED to full power
- Register current/brightness ratio
- Calculate and compensate power offset to first calibration value
- Correct Intensity linearization

## How do Colibri LED light sources contribute to a reduction of total cost of ownership compared to fibre-coupled metal-halide light sources?:

- Lifetime of LEDs is at least several times higher than that of metal-halide light bulbs
- Lifetime of liquid light guide is limited (3000–4000 h)
- LEDs are very energy efficient, as less heat is produced and rapid switching of LEDs helps saving energy

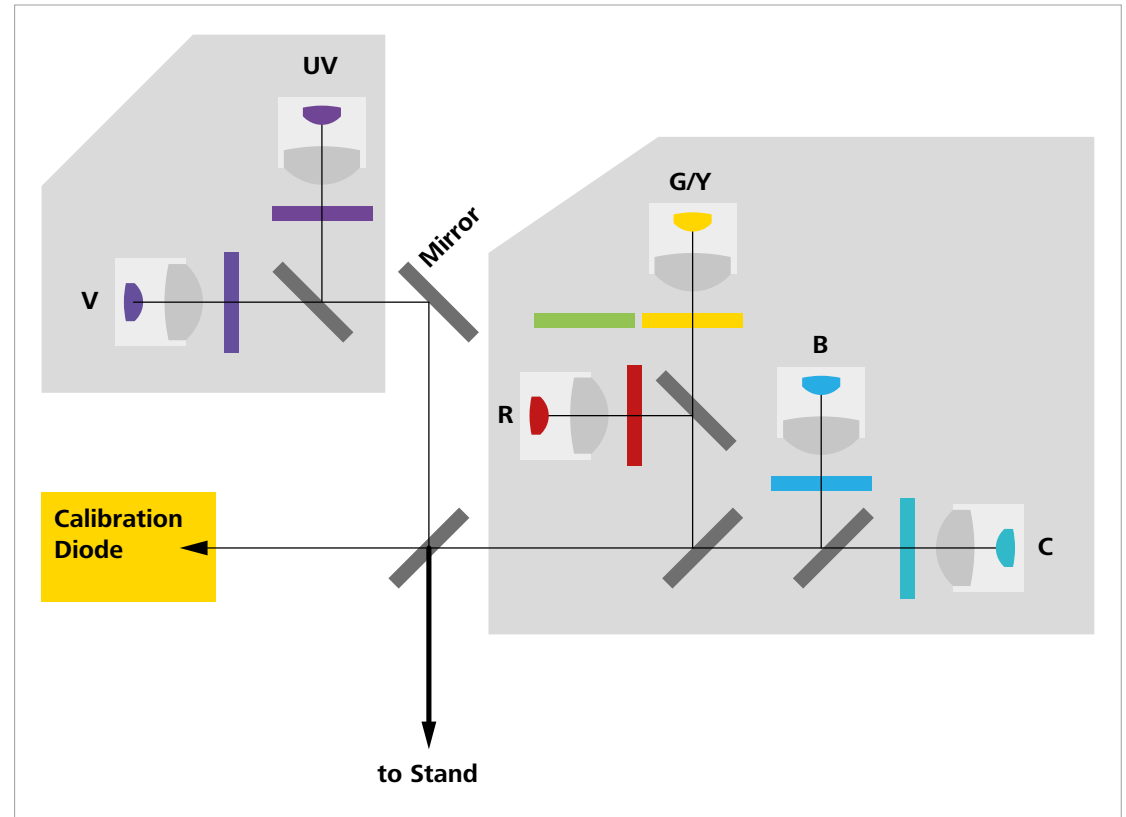

Schematic representation of 7-channel Colibri setup



# ZEISS Colibri 5 at Work

- › In Brief
- › The Advantages
- › **The Applications**
- › The System
- › Technology and Details
- › Service

- Replacement of mercury vapor light sources or other classical light sources
- Multicolor imaging with multi and single band filter sets
- Multicolor imaging with high frame rates
- Fast and gentle live cell imaging
- Routine fluorescence imaging and visual observation
- Fast multicolor tile imaging
- Quantative imaging in cell physiology or immunohistochemistry
- 2D and 3D imaging with Apotome 3
- 3D widefield imaging and deconvolution

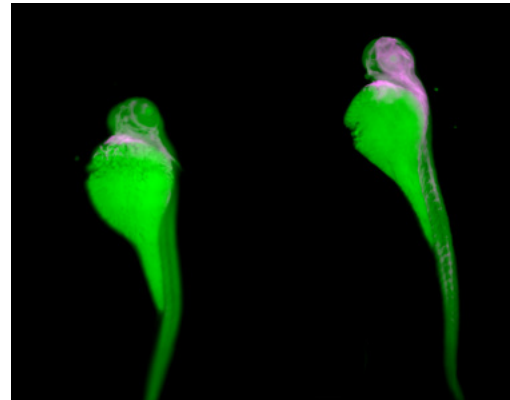

*Zebrafish expressing GFP, cells of the nervous system labelled in red.*

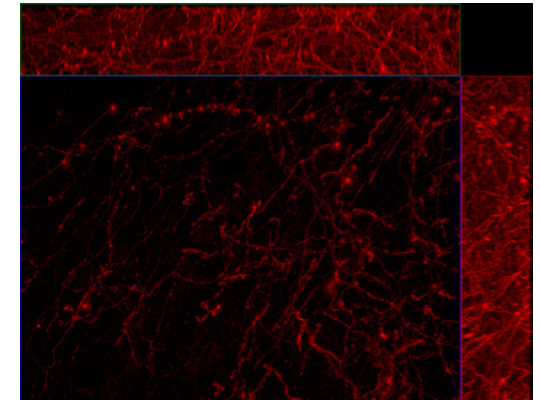

*Neuronal cell culture, stained with Cy5.*

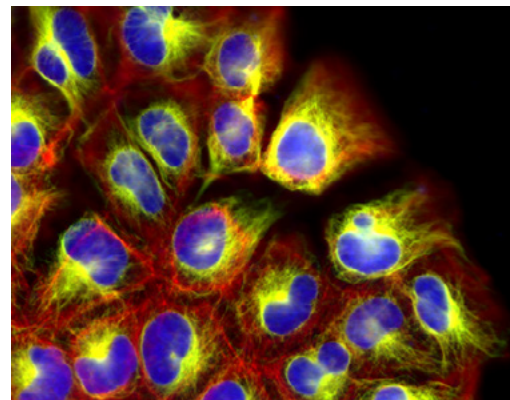

*COS7 cells, nuclei stained with Hoechst 33342, microtubules tagged with GFP, actin tagged with RFP.*

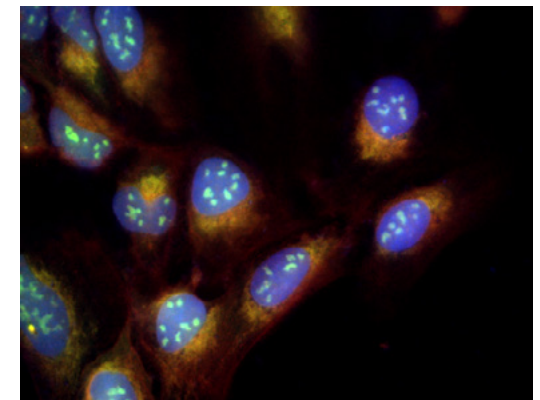

*COS7 cells, nuclei stained with Hoechst 33342, PML-bodies tagged with Alexa 488, actin tagged with Alexa 633.*

# ZEISS Colibri 7 at Work

- › In Brief
- › The Advantages
- › **The Applications**
- › The System
- › Technology and Details
- › Service

- Fast and gentle live cell imaging with up to 7 colors (using multi and single band filter sets)
- Multicolor imaging with high frame rates
- Demanding multicolor FISH applications
- FRET imaging or other dual-excitation imaging applications
- Fast multicolor tile imaging
- Long-term timelapse experiments
- Quantative imaging in cell physiology or immunohistochemistry
- 2D and 3D imaging with Apotome 3
- 3D widefield imaging and deconvolution
- Replacement of mercury vapor light sources (e.g. HBO and HXP) or other classical light-sources
- Routine fluorescence imaging and visual observation

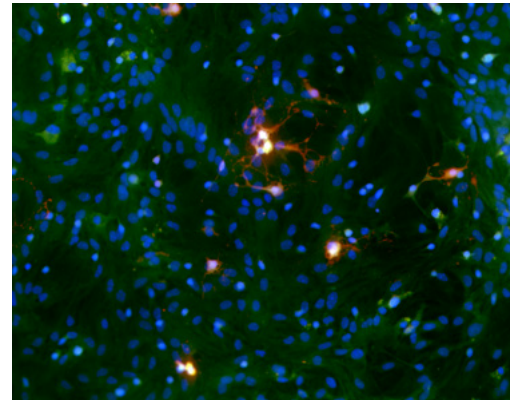

*Co-culture of mouse brain cells, astrocytes in green and neurons in red.*

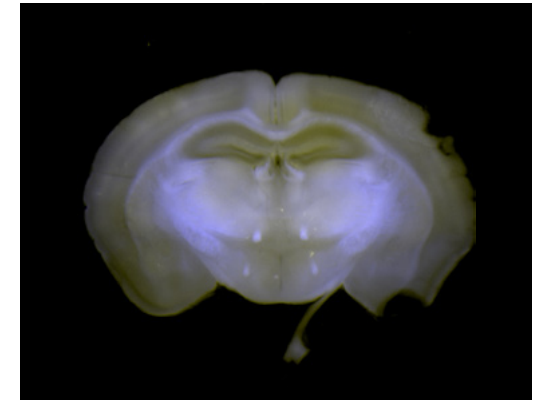

*Sliced mouse brain, neurons labeled with YFP. Sample courtesy of D. Richardson, HCB, Harvard University, Cambridge, MA.*

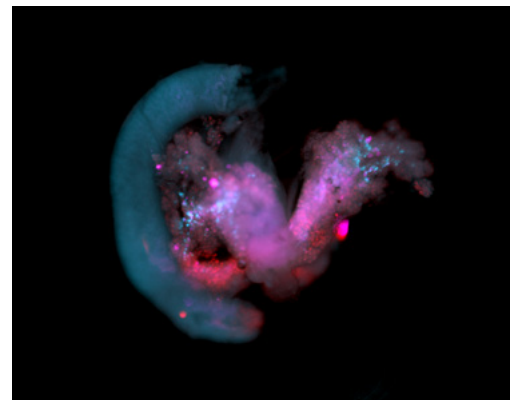

*Embryonic pancreas from a Ngn3-eGFP mouse, connected to the intestine, staining against muc1 (red). Sample courtesy of N. Sharon, Harvard University, Boston, MA.*

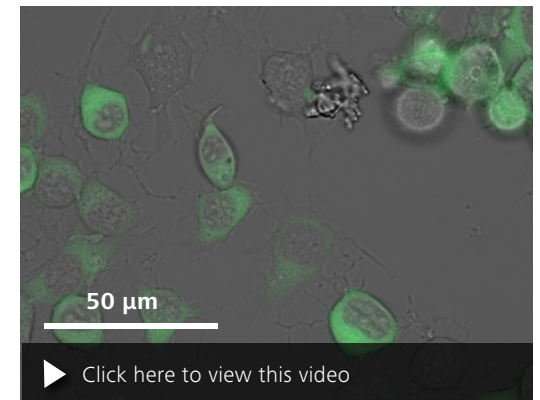

*HeLa cell culture with cytosolic eGFP, proliferation imaged over 16 hours.*

# ZEISS Colibri 7 at Work

- › In Brief
- › The Advantages
- › **The Applications**
- › The System
- › Technology and Details
- › Service

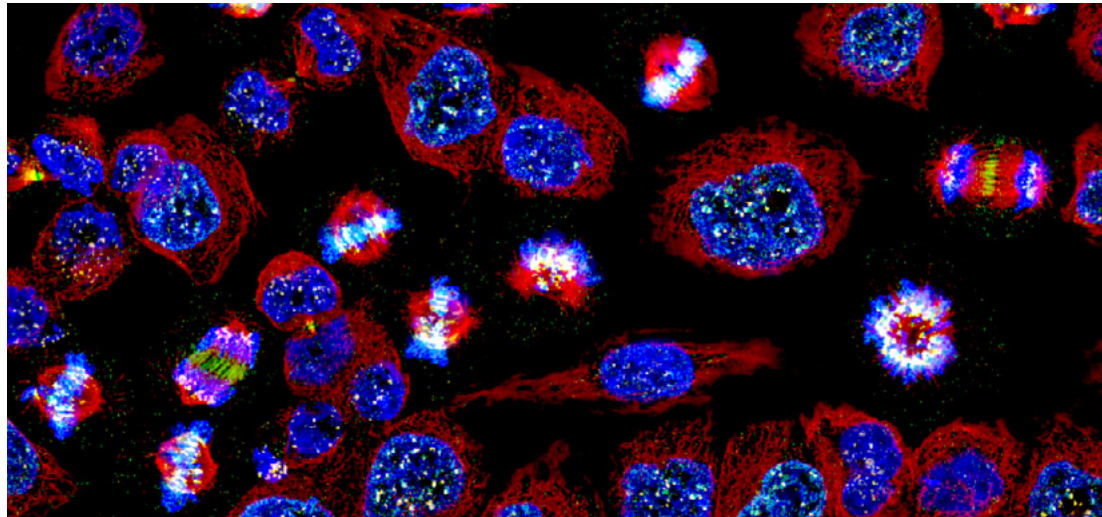

Fixed cultured HeLa Kyoto cells stained with Hoechst 33342 (blue), Aurora B – Alexa 488 (green), Tubulin – Alexa 568 (red) and ACA – Alexa 647 (white). Image stack was deconvolved using ZEN Deconvolution module. Sample courtesy of Dr. A. Girod, University of Luxembourg.

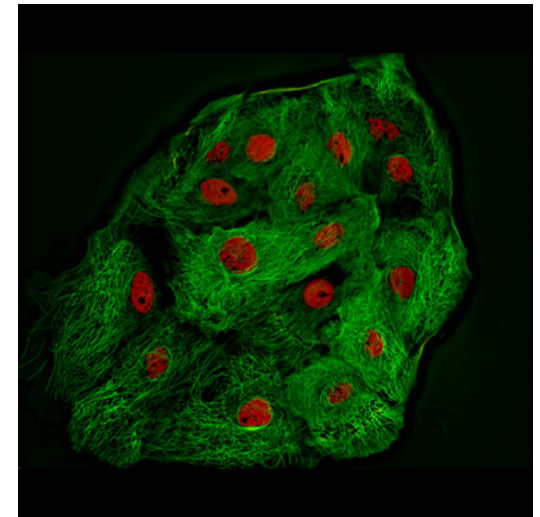

Living cultured pig kidney cells (LLC-PK1) with Emerald-Tubulin fusion (green) and mCherry-H2B fusion (red). Sample courtesy of M. Davidson, Florida State University.

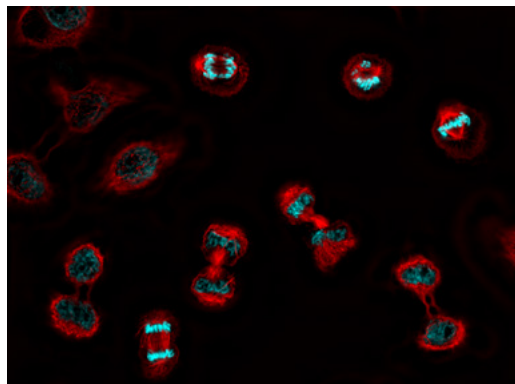

Fixed cultured HeLa Kyoto cells stained with Hoechst 33342 (blue), Importin  $\beta$  – Alexa 488 (green) and Tubulin – Alexa 647 (red). Image stack was deconvolved using ZEN Deconvolution module. Sample courtesy of Dr. A. Girod, University of Luxembourg.

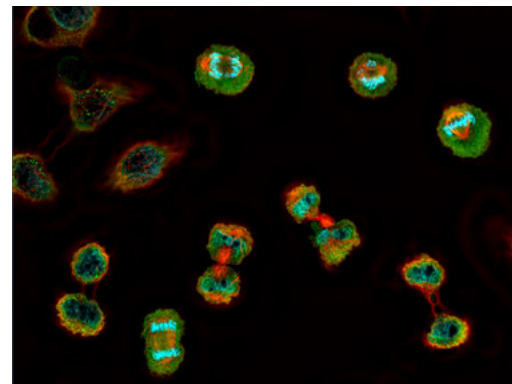

Fixed cultured HeLa Kyoto cells stained with Hoechst 33342 (blue), Importin  $\beta$  – Alexa 488 (green) and Tubulin – Alexa 647 (red). Image stack was deconvolved using ZEN Deconvolution module. Sample courtesy of Dr. A. Girod, University of Luxembourg.

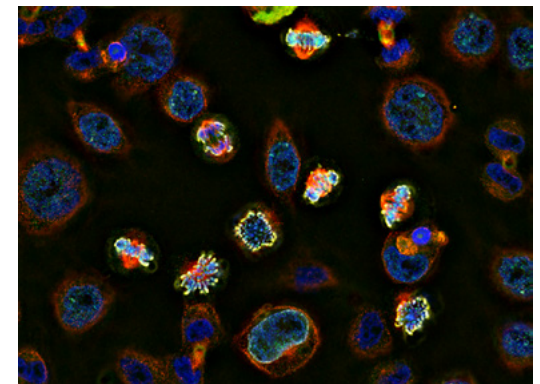

Fixed cultured HeLa Kyoto cells stained with Hoechst 33342 (blue), Aurora B – Alexa 488 (green), phospho-Histone H3 – Alexa 568 (orange), Tubulin – Alexa 647 (red). Image stack was deconvolved using ZEN Deconvolution module. Sample courtesy of Dr. A. Girod, University of Luxembourg.

# Tailored Precisely to Your Applications

- › In Brief
- › The Advantages
- › **The Applications**
- › The System
- › Technology and Details
- › Service

Spectral comparison of the Colibri LED light source with a common mixed gas lamp.

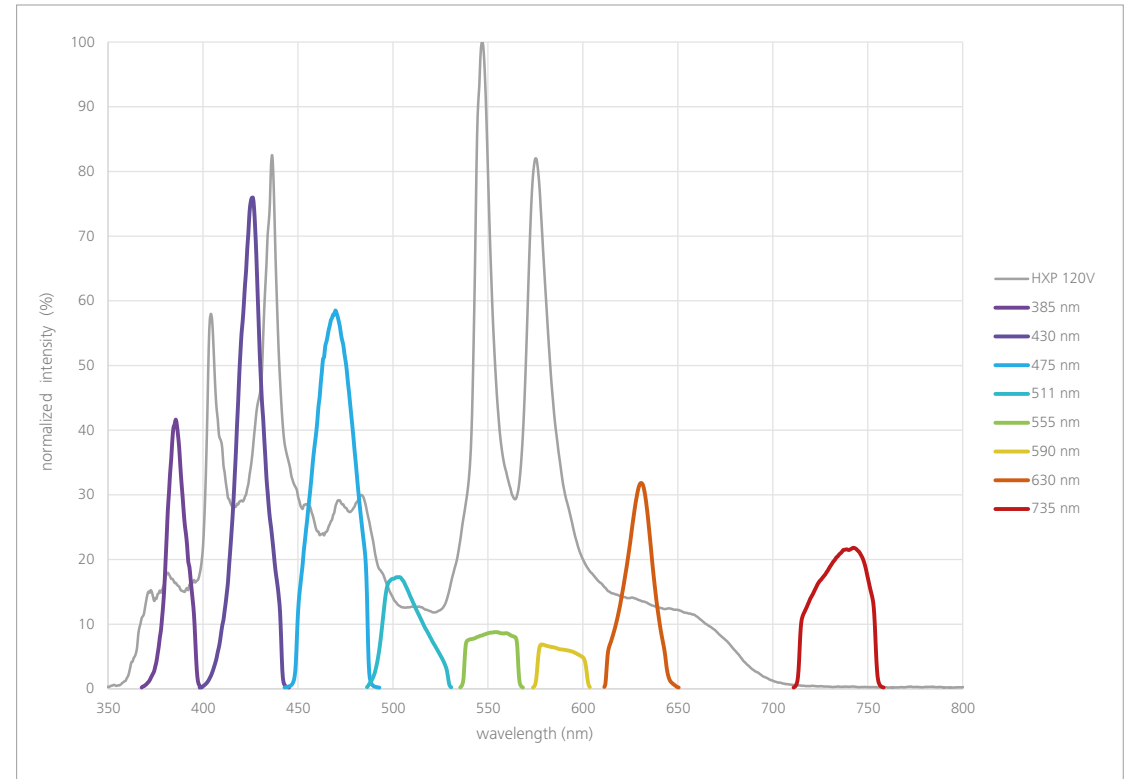

ZEISS Colibri 7 power comparison

# Your Flexible Choice of Components

- › In Brief
- › The Advantages
- › The Applications
- › **The System**
- › Technology and Details
- › Service

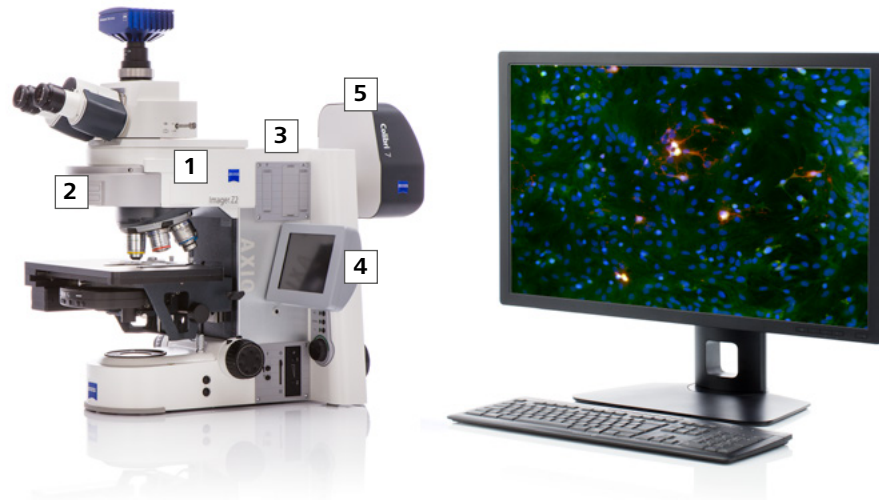

## 1 Microscopes

- Axio Imager
- Axio Examiner
- Axioscope
- Axioscan
- Axio Observer
- Axio Vert.A1

## 2 Filters

A selection of high efficiency filter sets were specifically designed for Colibri:

- FS 56 HE LED
- FS 90 HE LED
- FS 91 HE LED
- FS 92 HE LED
- FS 108 HE LED
- FS 109 HE LED
- FS 110 HE LED
- FS 112 HE LED

## 3 Software

ZEN (blue edition), recommended modules:

- Multi Channel
- Z Stack
- Time Lapse
- Tiles & Positions
- Deconvolution
- 3Dxl Viewer – powered by arivis®

## 4 Control

- TFT
- Control Panel
- TTL/Analog Voltage with LED Trigger Box

## 5 Others

- For maximum flexibility in excitation and emission, Colibri can be combined with the Axio Observer dual filter wheel (452358-9011-000) for rapid switching of dichroic and emission filters.

# System Overview

- › In Brief
- › The Advantages
- › The Applications
- › **The System**
- › Technology and Details
- › Service

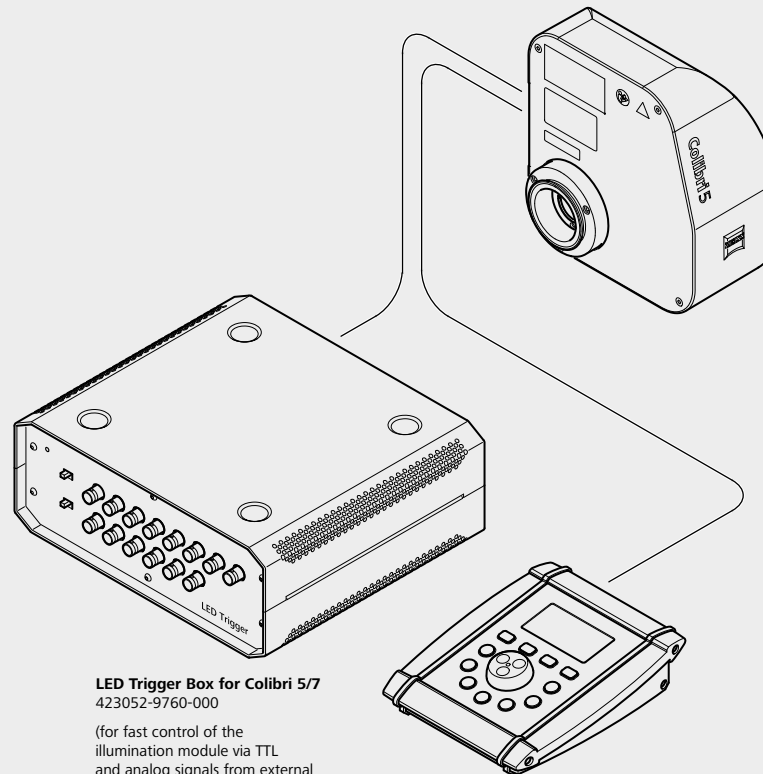

**Solid-State Light Source Colibri 5,  
Type RGB-UV**  
with 4 solid state LED lamps  
423052-9640-000

included in delivery:  
- illumination module,  
- desktop power supply and  
- country-specific power cable

**Filter set 90 HE LED**  
489090-9110-000

**LED Trigger Box for Colibri 5/7**  
423052-9760-000

(for fast control of the illumination module via TTL and analog signals from external software packages is needed)

**Control Panel for Colibri 5/7**  
423052-9751-000

(for manual stands without TFT control panel or software control is needed)

# System Overview

- › In Brief
- › The Advantages
- › The Applications
- › **The System**
- › Technology and Details
- › Service

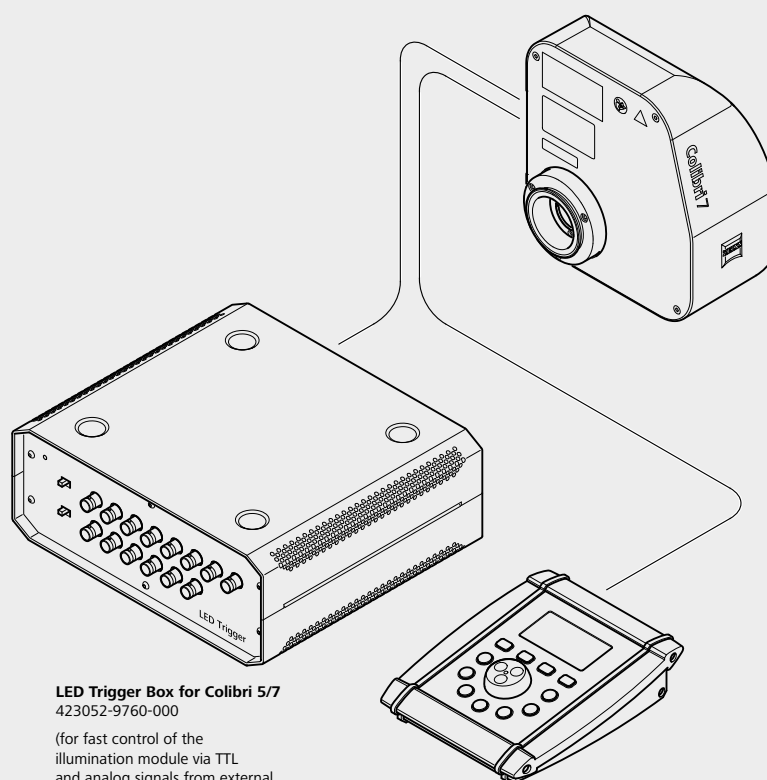

**LED Trigger Box for Colibri 5/7**  
423052-9760-000

(for fast control of the illumination module via TTL and analog signals from external software packages is needed)

**Control Panel for Colibri 5/7**  
423052-9751-000

(for manual stands without TFT control panel or software control is needed)

**Solid-State Light Source Colibri 7, Type RGB-UV**  
with 4 solid state LED lamps  
423052-9710-000

**Solid-State Light Source Colibri 7, Type RYB-UV**  
with 4 solid state LED lamps  
423052-9720-000

**Solid-State Light Source Colibri 7, Type R[G/Y]B-UV**  
with 5 excitation lines  
423052-9730-000

**Solid-State Light Source Colibri 7, Type R[G/Y]CBV-UV**  
with 7 excitation lines  
423052-9741-000

**Solid-State Light Source Colibri 7, Type FR-R[G/Y]BV-UV**  
with 7 excitation lines  
423052-9770-000

included in delivery:  
- illumination module,  
- desktop power supply and  
- country-specific power cable

Filter sets HE LED for use with Colibri 7:

**Filter set 56 HE LED**  
Suitable for fluorescent dyes like GFP and DsRed  
with excitation wavelengths 475 and 555 nm  
489056-9110-000

**Filter set 90 HE LED**  
Suitable for fluorescent dyes like DAPI, FITC, TRITC and Cy5  
with excitation wavelengths 385, 475, 555 and 630 nm  
489090-9110-000

**Filter set 91 HE LED**  
Suitable for fluorescent dyes like CFP, YFP and mCherry  
with excitation wavelengths 430, 511 and 590 nm  
489091-9110-000

**Filter set 92 HE LED**  
Suitable for fluorescent dyes like DAPI, GFP and mCherry  
with excitation wavelengths 385, 475 and 590 nm  
489092-9110-000

**Filter set 108 HE LED**  
Suitable for fluorescent dyes like CFP and YFP  
with excitation wavelengths 425 and 510 nm  
489108-9110-000

**Filter set 109 HE LED**  
Suitable for fluorescent dyes like DAPI, FITC and TRITC/Cy3  
with excitation wavelengths 385, 475 and 555 nm  
489109-9110-000

**Filter set 110 HE LED**  
Suitable for fluorescent dyes like DAPI, FITC, mCherry and Cy7  
with excitation wavelengths 385, 475, 555, and 735 nm  
489110-9111-000

# Your Flexible Choice of Components

- › In Brief
- › The Advantages
- › The Applications
- › **The System**
- › Technology and Details
- › Service

Order Number	Type	Comments
423052-9710-000	Solid-State Light Source Colibri 7, Type RGB-UV	385, 475, 555, 630
423052-9720-000	Solid-State Light Source Colibri 7, Type RYB-UV	385, 475, 590, 630
423052-9730-000	Solid-State Light Source Colibri 7, Type R[G/Y]B-UV	385, 475, 555, 590, 630
423052-9741-000	Solid-State Light Source Colibri 7, Type R[G/Y]CBV-UV	385, 430, 475, 511, 555, 590, 630
423052-9770-000	Solid-State Light Source Colibri 7, Type FR-R[G/Y]BV-UV	385, 430, 475, 555, 590, 630, 735
423052-9640-000	Solid-State Light Source Colibri 5, Type RGB-UV	385, 475, 555, 630
423052-9751-000	Control Panel for Colibri 5/7	optional, for manual control
423052-9760-000	LED Trigger Box for Colibri 5/7	optional, for triggering with 3 <sup>rd</sup> party hardware



# Your Flexible Choice of Components

- › In Brief
- › The Advantages
- › The Applications
- › **The System**
- › Technology and Details
- › Service

Filter Sets for ZEISS Colibri 5 and ZEISS Colibri 7

Order No.	Filter Set	UV 385/30	V 423/44	B 469/38	C 511/44	G 555/30	Y 590/27	R 631/33	FR 735/40	RGB-UV 423052-9710	RYB-UV 423052-9720	R[G/Y]B-UV 423052-9730	R[G/Y]CBV-UV 423052-9741	FR-R[G/Y]BV-UV 423052-9770
489096-9100-000	96 HE	●								●	●	●	●	●
489070-0000-000	70 HE		●										●	●
000000-1031-346	38			●						●	●	●	●	●
489038-9901-000	38 HE			●						●	●	●	●	●
000000-1114-101	43					●				●		●	●	●
489043-9901-000	43 HE					●				●		●	●	●
000000-1114-462	45						●				●	●	●	●
489064-0000-000	64 HE						●				●	●	●	●
488050-9901-000	50							●		●	●	●	●	●
489090-9100-000	90 HE ms	●		●		●		●		●		●	●	●
489090-9110-000	90 HE LED	●		●		●		●		●		●	●	●
489091-9110-000	91 HE LED		●		●		●						●	
489092-9110-000	92 HE LED	●		●			●				●	●	●	●
489056-9110-000	56 HE LED			●		●				●		●	●	●
489108-9110-000	108 HE LED		●		●								●	
489109-9110-000	109 HE LED	●		●		●				●		●	●	●
489110-9111-000	110 HE LED	●		●			●		●					●
489112-9110-000	112 HE LED			●		●		●	●					●

Note: Listed filter sets have been tested with Colibri 5/7. Filter sets that are not listed are not suitable for the combination with Colibri 5/7

# Your Flexible Choice of Components

- › In Brief
- › The Advantages
- › The Applications
- › **The System**
- › Technology and Details
- › Service

## Filter Sets for ZEISS Colibri 5 and ZEISS Colibri 7

### **489056-9110-000**

Filter set 56 HE LED (E)  
for use with the illumination system Colibri 5/7.

Suitable for fluorescent dyes like GFP and DsRed  
with excitation wavelengths 475 and 555 nm.

Contains beam splitter DBS 490 + 575 and  
emission filter DBP 512/30 + 630/98.

### **489092-9110-000**

Filter set 92 HE LED (E)  
for use with the illumination system Colibri 7.

Suitable for fluorescent dyes like DAPI, GFP and mCherry  
with excitation wavelengths 385, 475 and 590 nm.

Contains beam splitter TBS 405 + 493 + 610 and  
emission filter TBP 425/30 + 524/50 + 688/145.

### **489110-9111-000**

Filter Set 110 HE LED (E)  
for use with the illumination system Colibri 7.

Suitable for fluorescent dyes like DAPI, FITC, mCherry and Cy7  
with excitation wavelengths 385, 475, 590 and 735 nm.

Contains beam splitter QBS 405 + 493 + 611 + 762 and  
emission filter QBP 425/30 + 524/51 + 634/38 + 785/38.

### **489090-9110-000**

Filter set 90 HE LED (E)  
for use with the illumination system Colibri 5/7.

Suitable for fluorescent dyes like DAPI, FITC, TRITC and Cy5  
with excitation wavelengths 385, 475, 555 and 630 nm.

Contains beam splitter QBS 405 + 493 + 575 + 653 and  
emission filter QBP 425/30 + 514/30 + 592/30 + 709/100.

### **489108-9110-000**

Filter set 108 HE LED (E)  
for use with the illumination system Colibri 7.

Suitable for fluorescent dyes like CFP and YFP  
with excitation wavelengths 425 and 510 nm.

Contains beam splitter DBS 450 + 538 and  
emission filter DBP 467/24 + 598/110.

### **489112-9110-000**

Filter Set 112 HE LED (E)  
for use with the illumination system Colibri 7.

Suitable for fluorescent dyes like DAPI, FITC, DsRed, Cy5 and Cy7  
with excitation wavelengths 385, 475, 555, 630 and 735 nm.

Contains beam splitter PBS 405 + 493 + 575 + 654 + 761 and  
emission filter PBP 425/30 + 514/31 + 592/25 + 681/45 + 785/38.

### **489091-9110-000**

Filter set 91 HE LED (E)  
for use with the illumination system Colibri 7.

Suitable for fluorescent dyes like CFP, YFP and mCherry  
with excitation wavelengths 430, 511 and 590 nm.

Contains beam splitter TBS 450 + 538 + 610 and  
emission filter TBP 467/24 + 555/25 + 687/145.

### **489109-9110-000**

Filter set 109 HE LED (E)  
for use with the illumination system Colibri 5/7.

Suitable for fluorescent dyes like DAPI, FITC and TRITC/Cy3  
with excitation wavelengths 385, 475 and 555 nm.

Contains beam splitter TBS 405 + 493 + 575 and  
emission filter TBP 425/29 + 514/31 + 632/100.

# Technical Specifications

- › In Brief
- › The Advantages
- › The Applications
- › The System
- › **Technology and Details**
- › Service

## LED light source for fluorescence applications

Up to 7 individually controlled excitation lines (Colibri 7)

Linearized intensity regulation in increments of 1 % (from 1 – 100 %)

Standby mode to reduce power consumption

Real-time stabilization of brightness for low-noise image captures (Colibri 7)

Long-time stabilization and performance optimization to improve comparability of image captures (Colibri 7)

Integrated and motorized (Colibri 7) switchable excitation filters

Control via the TFT display of Axio Observer 7

Optional control via ZEN Imaging Software, manual control panel or Trigger Box

Easy integration in 3rd party software packages via LED Trigger Box

Guaranteed lifetime of 15,000 h per LED line

Integrated interface for triggered image capture from ZEN Imaging Software

## Dimensions

Light source (length × width × height)	167 mm × 183 mm × 103 mm
LED Trigger Box (length × width × height)	220 mm × 245 mm × 105 mm
Control panel (length × width × height)	180 mm × 110 mm × 70 mm

## Weight

Light source	up to 1,900 g
LED Trigger Box	approx. 2,100 g
Control panel	approx. 590 g

## Excitation wavelengths

Solid-state light source Colibri 5, type RGB-UV	630, 555, 475, 385 nm
Solid-state light source Colibri 7, type RGB-UV	630, 555, 475, 385 nm
Solid-state light source Colibri 7, type RYB-UV	630, 590, 475, 385 nm
Solid-state light source Colibri 7, type R[G/Y]B-UV	630, 590, 555, 475, 385 nm
Solid-state light source Colibri 7, type R[G/Y]CBV-UV	630, 590, 555, 511, 475, 430, 385 nm
Solid-state light source Colibri 7, type FR-R[G/Y]BV-UV	735, 630, 590, 555, 475, 430, 385 nm

# Technical Specifications

- › In Brief
- › The Advantages
- › The Applications
- › The System
- › **Technology and Details**
- › Service

## Ambient conditions

### Transport (in packaging)

Permissible ambient temperature	-40 °C to +70 °C
---------------------------------	------------------

### Storage

Permissible ambient temperature	+10 °C to +40 °C
Permissible relative air humidity (no condensation)	max. 75 % at 35 °C

### Operation

Permissible ambient temperature	+10 °C to +40 °C
Permissible relative air humidity (no condensation)	max. 75 % at 35 °C
Altitude of operating site	max. 2000 m
Atmospheric pressure	800 hPa to 1060 hPa
Degree of pollution	2

## Operating data

Operating area	Enclosed rooms
Protection class	I
Ingress protection rating	IP 20
Electrical safety	in compliance with DIN EN 61010-1 (IEC 61010-1) and conforming to CSA and UL regulations
Overvoltage category	II
Radio interference suppression	in compliance with EN 55011 Class B
Noise immunity	in accordance with DIN EN 61326-1
Line voltage of controller module	100 to 240 VAC (±10 %)
Line frequency	50 to 60 Hz
Power consumption of controller module	70 VA

# Technical Specifications

- › In Brief
- › The Advantages
- › The Applications
- › The System
- › **Technology and Details**
- › Service

## System Requirements ZEISS Colibri 5 and ZEISS Colibri 7

### ZEISS Colibri 5 and ZEISS Colibri 7 Compatibility Notes

---

Control via TFT is available for Axio Observer 3/5/7, Axio Examiner.Z and Axio Imager 2 (M, Mm, Z and Zm)

---

Colibri 5 and Colibri 7 cannot be controlled via ZEN (black edition) and software packages prior MTB Version 2.7.0.4, ZEN (blue edition), DVD 66

---

Fast excitation filter wheel cannot be combined with Colibri 5 and Colibri 7

---

LEDs and excitation filters are pre-configured and no customer interfaces

---

# Count on Service in the True Sense of the Word

- › In Brief
- › The Advantages
- › The Applications
- › The System
- › Technology and Details
- › **Service**

Because the ZEISS microscope system is one of your most important tools, we make sure it is always ready to perform. What's more, we'll see to it that you are employing all the options that get the best from your microscope. You can choose from a range of service products, each delivered by highly qualified ZEISS specialists who will support you long beyond the purchase of your system. Our aim is to enable you to experience those special moments that inspire your work.

## **Repair. Maintain. Optimize.**

Attain maximum uptime with your microscope. A ZEISS Protect Service Agreement lets you budget for operating costs, all the while reducing costly downtime and achieving the best results through the improved performance of your system. Choose from service agreements designed to give you a range of options and control levels. We'll work with you to select the service program that addresses your system needs and usage requirements, in line with your organization's standard practices.

Our service on-demand also brings you distinct advantages. ZEISS service staff will analyze issues at hand and resolve them – whether using remote maintenance software or working on site.

## **Enhance Your Microscope System.**

Your ZEISS microscope system is designed for a variety of updates: open interfaces allow you to maintain a high technological level at all times. As a result you'll work more efficiently now, while extending the productive lifetime of your microscope as new update possibilities come on stream.



*Profit from the optimized performance of your microscope system with services from ZEISS – now and for years to come.*

>> [www.zeiss.com/microservice](http://www.zeiss.com/microservice)



**Carl Zeiss Microscopy GmbH**  
07745 Jena, Germany  
microscopy@zeiss.com  
www.zeiss.com/colibri

