

X-Cite[®] *exacte* User Guide

X-Cite® *exacte* User Guide

035-00283 Rev. 3

Made in Canada

Excelitas Canada Inc. 2016

All rights reserved

No part of this publication may be reproduced, transmitted, transcribed, stored in a retrieval system or translated into any language in any form by any means without the prior written consent of Excelitas Canada Inc. Every effort has been made to ensure information in this manual is accurate; however, information in this manual is subject to change without notice and does not represent a commitment on the part of the authors.



Excelitas Canada Inc.
2260 Argentia Road
Mississauga ON L5N 6H7 CANADA

Trademarks

X-Cite®, *exacte*, Intelli-Lamp®, and Closed-Loop Feedback are registered trademarks of Excelitas Canada Inc. All rights reserved.

All other product names are trademarks of their respective owners.

Table of Contents

1. X-Cite® exacte Message Reference	1
2. Introduction	2
3. Safety	3
3.1 Glossary of Symbols.....	3
3.2 Safety Precautions	4
4. Getting Started	7
4.1 System Components	7
4.2 Front Panel.....	8
4.3 Rear Panel	9
5. Installation/Set-up	10
5.1 Installing Lamp Module.....	10
5.2 Inserting/Removing Light Guide	13
5.3 Tips to Prevent Premature Degradation of Light Guides	15
5.4 Installing the Collimating Adapter	16
6. Operation	18
6.1 Powering Up/Powering Down	18
6.2 Quick Start: Illuminating a Specimen	19
6.3 Front Panel Button Functions	19
6.4 LED Indicators.....	20
6.5 Display Format Reference	20
6.6 Output Intensity Modes.....	21
6.7 Adjusting Light Output	21
6.8 Viewing Accumulated Lamp Hours	22
6.9 Closed-Loop Feedback™ (CLF).....	22
7. Calibration/Radiometry (optional)	24
7.1 X-Cite® exacte Power Reading using the XR2100 Power Meter or XR2000;	24
7.2 X-Cite® exacte Calibration using the XR2100 (or XR2000) & Light Guide.....	25
7.3 Calibrating X-Cite® exacte with the Objective Plane Power Sensor, XP750.....	25
7.4 To Clear a Calibration.....	26
8. Warnings and Alarms	27
8.1 Clearing Alarms	28
9. External Control	29
9.1 Graphical User Interface (GUI)	29
9.2 Installation:	29
9.3 Graphical User Interface Panel.....	30
9.4 Icons and Functions:	31
9.5 Logging Stability Data.....	33
9.6 Logging Events.....	33
9.7 Exporting Logged Data.....	33
9.8 Shutter Control via Foot pedal	34
9.9 Shutter control via TTL	34
9.10 Software Developer's Kit (SDK)	35
10. Troubleshooting	36
10.1 Error Codes.....	36

10.2	Power Up Failure	37
10.3	Lamp Strike Failure	37
10.4	Low Light Intensity	38
10.5	Shutter Failure.....	38
10.6	LED Display Failure	38
10.7	Cooling Fan Failure.....	38
11.	Care and Maintenance	39
11.1	General	39
11.2	Liquid Light Guides	40
11.3	Lamps	43
11.4	Replacing the Lamp Module.....	44
11.5	Air Vents & Filters	45
11.6	Replacing the Air Filter.....	47
11.7	Replacing the External Fuses.....	47
12.	Technical Specifications	48
12.1	Electrical	48
12.2	Environmental	48
12.3	Lamp.....	49
12.4	Light Guide.....	50
12.5	General	50
13.	Regulatory	51
13.1	Product Safety and Electromagnetic Compatibility:	51
13.2	China RoHS	52
14.	Warranty	53
15.	Contact Information	54
15.1	Replacement Parts and Accessories.....	54

1. X-Cite® exacte Message Reference

Display Message	Definition	Description
XXX	Intensity Setting (%)	Displays the iris setting, which gives relative intensity as percentage of the lamp's maximum output
XX.XX	Power Setting (watts)	Displays the power setting, which gives absolute intensity in terms of watts
uXXX	Power Setting (microwatts)	Displays the power setting, which gives absolute intensity in terms of microwatts
X.XXX or XXX.X	Power Setting (milliwatts)	Displays the power setting, which gives absolute intensity in terms of milliwatts
XXXX.	Lamp Hours	Displays the "hours of use" accumulated by the lamp
Flashing: "XXXX"	Warming Up	The lamp is warming up. Warm up time is approximately 4 minutes ref section 6.1
bulb	Lamp Error	Lamp installed incorrectly / Lamp did not strike. See section 10.3
cool	Lamp is too hot to strike	The lamp will automatically strike when it has cooled to the optimum striking temperature. See section 10.3
Alternating: old / bulb	Old Lamp	The lamp has accumulated over 2500 hours. Lamp may be near end of life.
Alternating: end / bulb	New Lamp Required	The lamp has reached end of life. The lamp will not strike.
LOC	Front Panel Locked	All front panel buttons have been locked to prevent settings from being changed.
SFI	Shutter Failure	The shutter has failed to return to home position. Unit should be restarted. If the error repeats, contact Tech Support .
E1	Lamp temperature is too high	Check ventilation filters and outlets to ensure that no blockage exists. Restart unit and if problem persists replace lamp. If problem continues contact Tech Support
E2	Internal communication failure	Restart unit, if problem persists contact Tech Support
E3	Iris failed to go to home position	Restart unit, if problem persists contact Tech Support
E4	Internal hardware failure	Restart unit, if problem persists contact Tech Support
E5	Failure to communicate with Intelli-Lamp®	Check Intelli-Lamp® connection and restart unit. If problem persists try another lamp, if problem still persist contact Tech Support .
E6	Lamp self extinguished	Let system cool and restart lamp. If it goes out again, replace lamp. If new lamp continues to self-extinguish, contact Tech Support
E7	Internal system error	Restart unit, if problem persists contact Tech Support

See Section 10 for troubleshooting.

2. Introduction

The X-Cite® *exacte* is a revolution in fluorescence microscopy illumination. Like the previous X-Cite® illuminators, the X-Cite® *exacte* has the convenience of pre-aligned, long-life Intelli-Lamps®, easy installation and compatibility with all major microscope brands. With additional features such as Closed-Loop Feedback™, intensity adjustment in 1% increments, a high speed internal shutter, and a calibrated output option which is compatible with the X-Cite® Optical Power Measurement System, the X-Cite® *exacte* reaches a new level of performance that makes it the ideal choice for quantitative, comparative, and live cell imaging.

Excelitas Technologies Corp. is a global technology leader focused on delivering innovative, customized solutions to meet the lighting, detection and other high-performance technology needs of customers. X-Cite®, formerly of Lumen Dynamics (which was acquired by Excelitas Technologies Corp. in November 2013) offers the Life Science and Analytical Instrumentation market a broad range of innovative lamp and LED fluorescence illumination and measurement solutions.

The X-Cite® *exacte* is a high quality product manufactured in accordance with ISO 9001, CE marked and certified to UL, China RoHS and CSA standards.

We suggest that you read this manual to discover all its features, and how to use them.

Thank you for choosing X-Cite®!

3. Safety

3.1 Glossary of Symbols



CAUTION - Risk of danger: consult accompanying documents



WARNING -Eye damage may result from directly viewing ultraviolet light – protective eye shielding and clothing must be used at all times.



Input/Output Signals

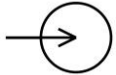

Input Signal



CAUTION – Hot Surface

3.2 Safety Precautions

The X-Cite[®] *exacte* is equipped with two safety sensors to protect the user from accidental UV exposure. In addition, please observe the following precautions during use. This series of cautions, warnings and dangers relate to the operation and maintenance of the X-Cite[®] *exacte*. They are also presented throughout this User's Guide where necessary.



Warning

Eye damage may result from directly viewing the light produced by the lamp used in this product. Always use protective eyewear and turn the lamp off before removing cover.



Caution

Never look into the light emitting end of the light guide. The light could severely damage the cornea and retina of the eye if the light is observed directly. Eye shielding must be used at all times as well as clothing to protect exposed skin.



Warning

Always make sure the light guide is properly inserted into the X-Cite[®] *exacte* and the microscope prior to turning on power to the unit. This will minimize the risk of exposure to the UV light.



Caution!

To prevent damage/ degradation of the light guide, always allow adequate clearance at the front of the X-Cite[®] *exacte* unit to prevent kinking or excessive bending.



Warning

To reduce the risk of fire or shock, always replace the fuses with the same type and rating.



Warning

Disconnecting of main supply source is only possible by unplugging the power cord.



Danger

This unit contains HIGH VOLTAGE components. It is recommended that ONLY QUALIFIED TECHNICAL PERSONNEL perform any testing or repairs described in this manual. Disconnect the AC power cord from the unit before opening the cover of this unit. All cover screws must be replaced prior to applying power to the unit, or safety of the unit will be impaired.

Monitoring the unit during manual operation

The level of UV and visible energy supplied by the X-Cite® *exacte* is sufficient to ignite flammable substances. During manual operation, the unit must be attended at all times by a qualified operator. The unit must not be left unattended while turned on. If an operator leaves the work area of the unit, the lamp power switch must be turned off.



Monitoring the unit during Automated operation

The level of UV and visible energy supplied by the X-Cite® *exacte* is sufficient to ignite flammable substances. Therefore, when the unit is operated unattended in an automated environment, an alarm function must be provided by the user to indicate a malfunction in the associated equipment used.



Warning

Hg – LAMP CONTAINS MERCURY, Manage in Accord with Disposal Laws, see: www.lamprecycle.org or 1-800-668-8752

Danger: Exposure to Mercury represents a health hazard to humans.

*When unpacking or installing the lamp, always wear protective clothing and a face mask. Operate the lamp inside the X-Cite® *exacte* housing only. This prevents direct viewing of the arc and in the case of lamp bursting, contains the lamp particles. In the rare instance in which a lamp bursting occurs, and the mercury content is released, the following safety precautions are recommended; all personnel should be immediately evacuated from the area to prevent inhalation of the mercury vapour. The area should be well ventilated for a minimum of 30 minutes. Prior to clean up ensure an 'approved-for-mercury' respirator mask and non-porous gloves such as latex or rubber are used. After the lamp housing elements have cooled, the mercury residue should be collected with the use of a special absorbing agent available from laboratory equipment suppliers.*

Listed below are examples of internet web sites for obtaining Mercury Spill Kits;

- <http://www.rosshealthcare.org/Mercon.spill.kits.htm>
- http://www.coleparmer.ca/catalog/product_index.asp?cls=43577
- <http://www.environmental-expert.com/technology.aspx?idCategory=2054&word=mercury%20spill%20kits>
- http://www.alibaba.com/products/spill_kit/4.html



Warning

Should this X-Cite® *exacte* unit be used in a manner not specified by Excelitas Technologies, the protection provided by the equipment may be impaired.

**Warning**

The method in which lamps are disposed of must comply with local rules and regulations for disposal of hazardous materials. Lamps may be returned to Excelitas Technologies providing they are returned in their original packaging. Excelitas Technologies will dispose of them in the appropriate manner.

**Warning**

This unit is designed for bench top use only! Always ensure that the unit is operated on a hard, stable surface. This will prevent obstruction of the bottom chassis ventilation openings. Any obstruction of these openings could result in a possible over-heating condition. Do not attempt to remove or tamper with the rubber feet located on the bottom of the unit.

**Caution**

The lamp module's operational life can be significantly shortened if it is handled incorrectly. Do not touch the bulb's glass envelope or the inside surface of the reflector. Skin oils can cause the lamp module to fail prematurely.

**Caution**

Prior to opening the unit and handling the lamp module, allow a minimum of 5 minutes for the lamp module to cool down completely.

**Caution**

Any electronic equipment connected to the X-Cite® *exacte* must comply with the requirements of EN/IEC 60950.

**Cleaning:**

Clean the exterior of the unit with a slightly dampened cloth and simple water/detergent solution only.

4. Getting Started

4.1 System Components

Carefully unpack the unit and accessories. Ensure that all components are present. Store the packing material for future use.

Box Contents:

- | | |
|----------------------------------------------------------------------------------------------------------------------------------------------------------------------------------------------------------------------------------------------|--------------------------|
| 1. X-Cite [®] <i>exacte</i> Illumination Unit..... | <input type="checkbox"/> |
| 2. Lamp Module, X-Cite [®] <i>exacte</i> | <input type="checkbox"/> |
| 3. Microscope Adapter (if ordered)..... | <input type="checkbox"/> |
| 4. Liquid Light Guide (3mm x 1.5m or 3mm x 3.0m)..... | <input type="checkbox"/> |
| 5. Power Cord, IEC (shielded and grounded)..... | <input type="checkbox"/> |
| 6. Quick Start Guide, X-Cite [®] <i>exacte</i> (User Guide, Software and Driver downloads: http://www.excelitas.com/Pages/Product/X-Cite-exacte.aspx)..... | <input type="checkbox"/> |
| 7. Foot Pedal Switch Assembly..... | <input type="checkbox"/> |
| 8. USB Cable (A-B type)..... | <input type="checkbox"/> |
| 9. Hex Key, 3mm (Lamp access cover)..... | <input type="checkbox"/> |
| 10. Safety Precautions Booklet..... | <input type="checkbox"/> |

If your packaged unit is missing any of the above components, call Excelitas Technologies at (905) 821-2600 or TOLL FREE 1-800-668-8752.

Any additional optional items purchased to customize the unit will also be present.

X-Cite[®] *exacte* Control Panel Software

Minimum Computer Specifications:

- 300+ MHz processor (Pentium or equivalent)
- Windows 2000 SP4 or Windows XP SP2
- 128 MB of system memory (RAM)
- 5 MB available storage for software installation
- 20 MB (minimum) for data storage
- SVGA 1024 x 768 resolution, 16 bit colour
- One available USB 1.1 port

4.2 Front Panel

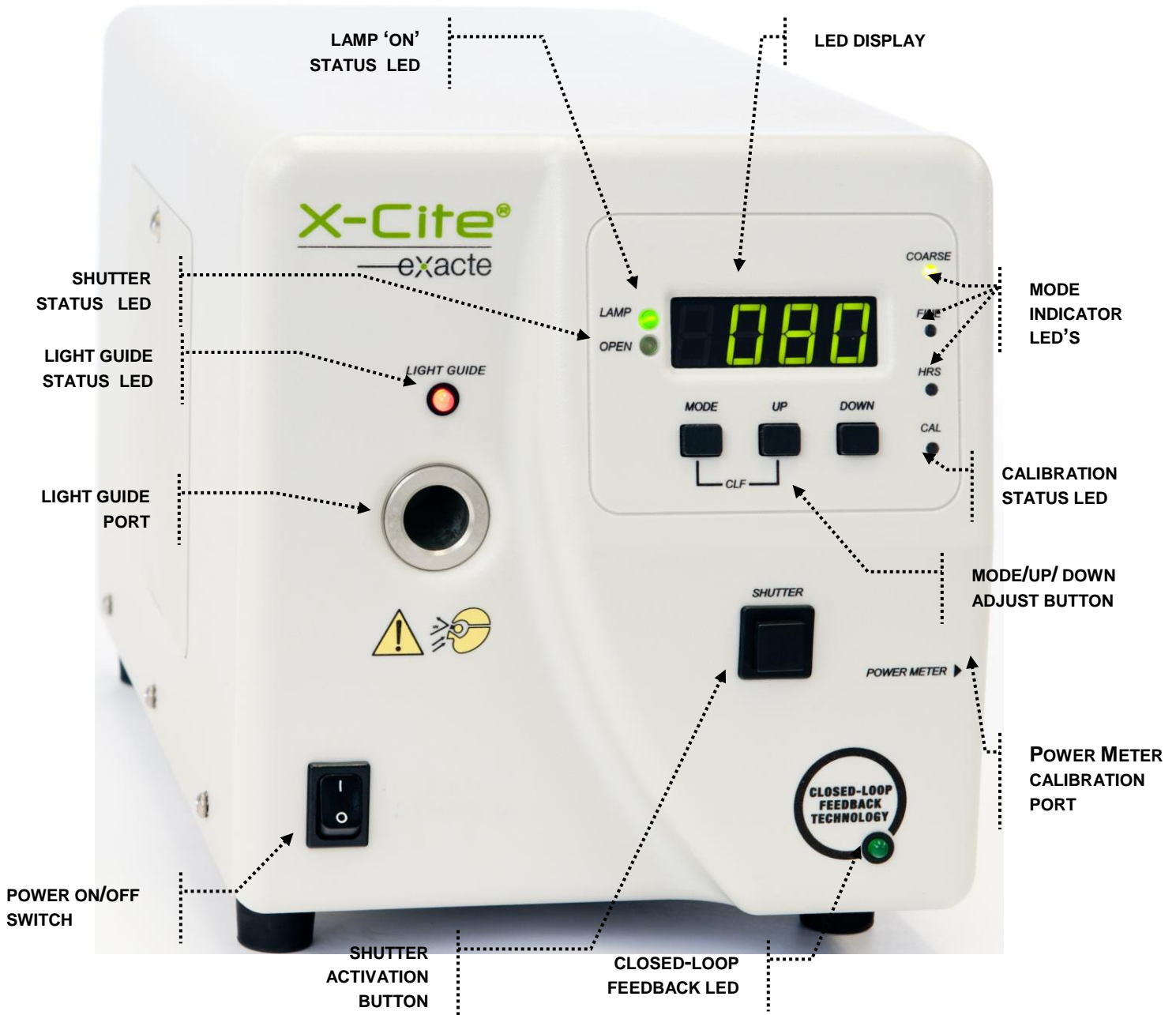

Figure 1 Front Panel

4.3 Rear Panel

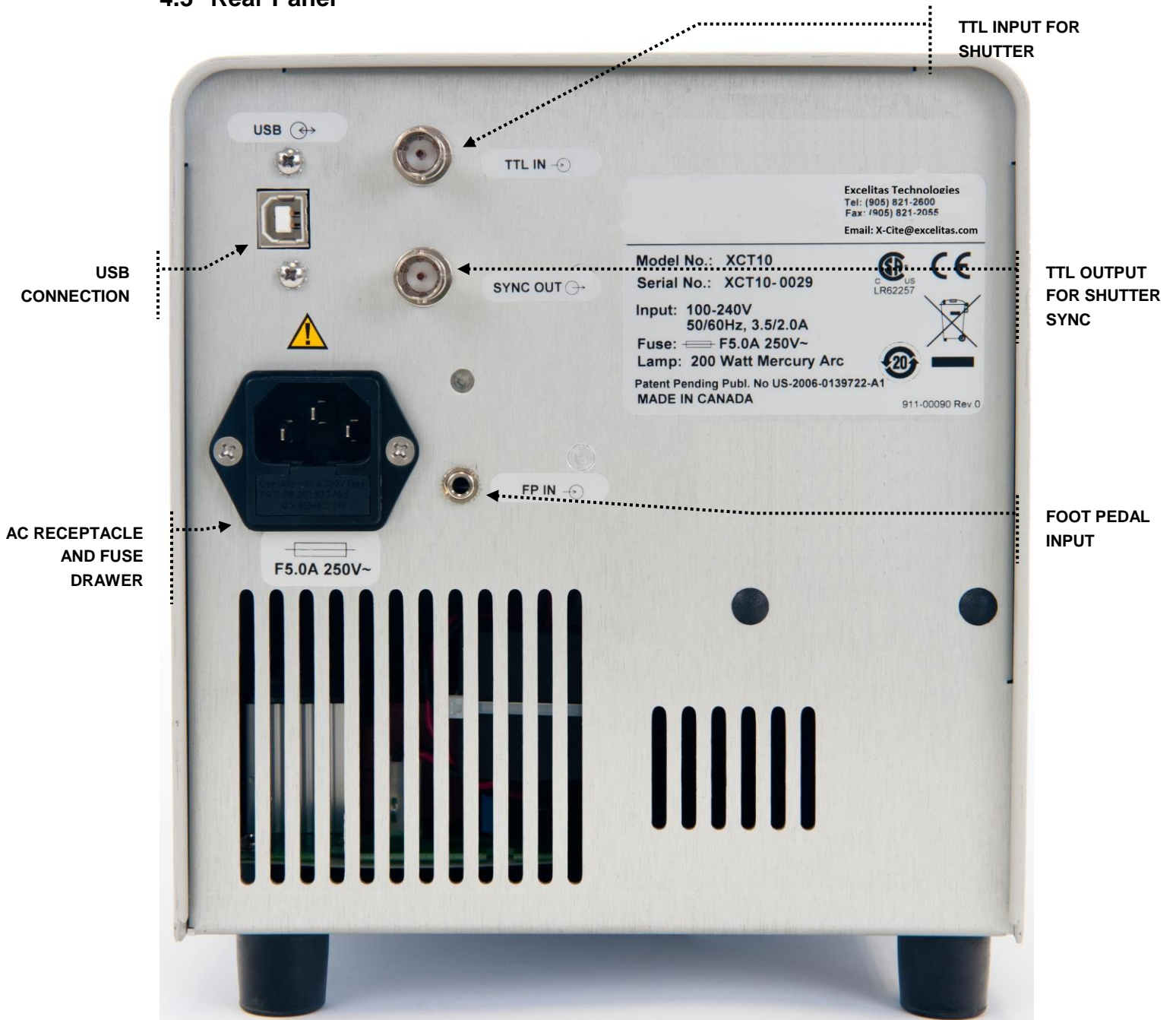

Figure 2 Rear Panel

5. Installation/Set-up

5.1 Installing Lamp Module

Note: Review Section 2 – Safety Precautions before proceeding

- 5.1.1 Be sure the AC POWER cord is disconnected from the unit.
- 5.1.2 Remove the screw from the lamp housing side panel using the 3mm hex tool provided and remove the panel from the unit cover.

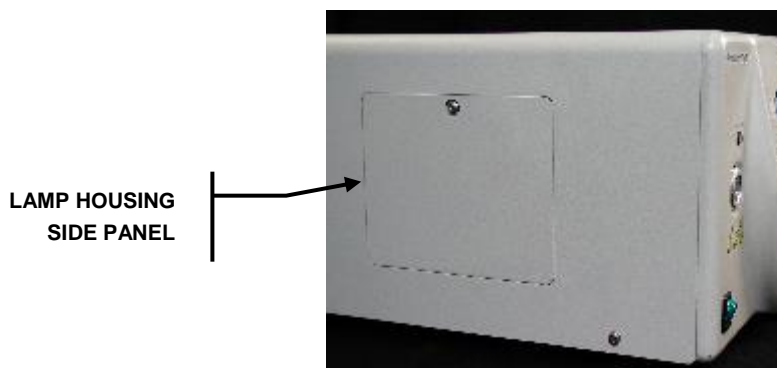

Figure 3 Side Panel

Tip: Clips for holding the hex tool on the X-Cite® exacte are conveniently located underneath the system housing.

- 5.1.3 Carefully remove the lamp module from its container, holding only the ceramic component and lamp rim.



Caution! The lamp module's operational life can be significantly shortened if handled incorrectly. Be sure only to handle the ceramic surfaces and the lamp rim. Do not touch the bulb's glass envelope or the inside surface of the reflector. Skin oils can cause the lamp module to fail prematurely.

- 5.1.4 As illustrated below, position the lamp facing towards the front of the unit with the POWER leads facing towards you. The lamp should be aligned so that the leading edge of the reflector (lamp rim) fits into the mounting groove on the lamp holder assembly.

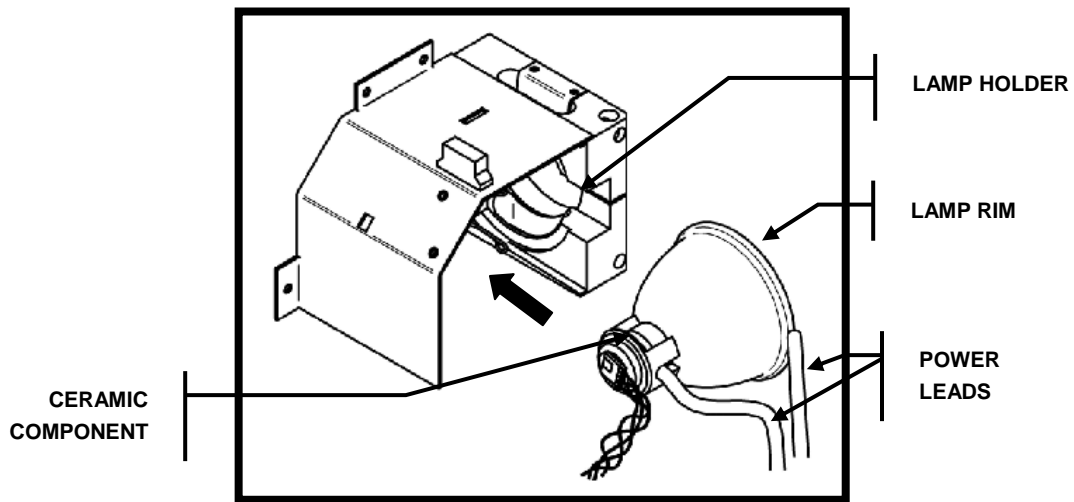
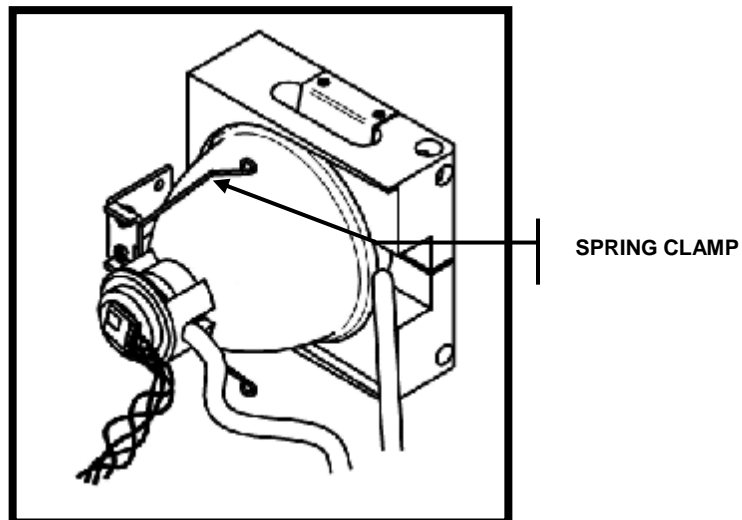

Figure 4 Lamp Housing

- 5.1.5 Make sure the middle of the lamp is in position to fit into the spring clamp. Slide the lamp until it snaps into the spring clamp. The leading edge of the reflector (lamp rim) should fit snugly into the lamp holder recess.



- 5.1.6 Locate the 4-pin Intelli-Lamp sensor connector at the rear of the lamp module and connect it to its mate located on the top of the lamp-housing wall.

Tip: The Intelli-Lamp connector will only attach in the correct orientation. If you are having difficulty attaching the connector, try rotating it by 180°.

Note: If the Intelli-Lamp connector is not installed correctly, the lamp will not strike and the “**bulb**” message will display when POWER is turned on to the unit.

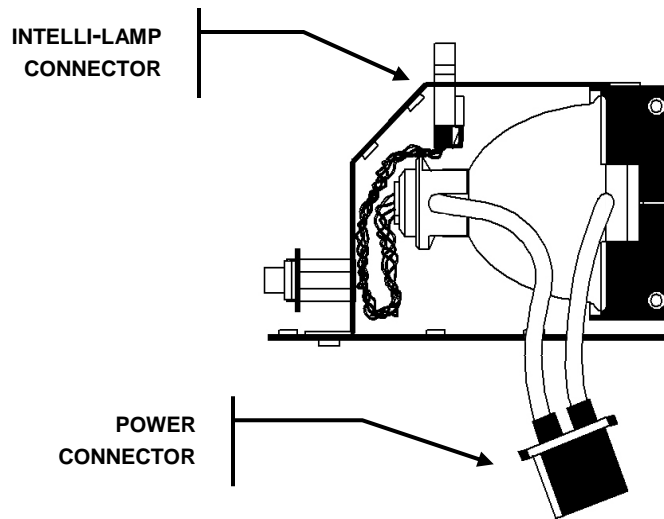
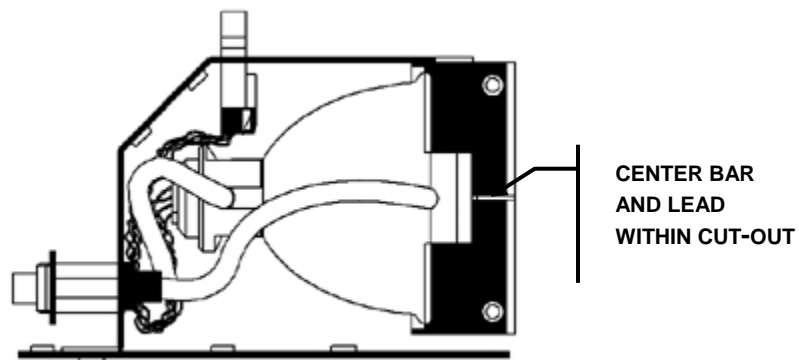

Figure 5 Lamp connections

- 5.1.7 Locate power connector with two leads and connect it to its mate located on the side of the lamp-housing wall.



5.1.8 Ensure the lamp anode cooling fin (bar) and lamp power lead, at the front of the lamp, are centered within the lamp holder cut-out. Rotate the lamp as required.

5.1.9 Replace the lamp housing side panel and tighten the fastening screw.

Note: *If the lamp housing panel is not secured completely the lamp will not strike and the “**bulb**” message will display when power is turned on to the unit.*

5.1.10 Replace the hex tool in the clips underneath the system for future use.

Warning This unit is designed for bench top use only! Always ensure that the unit is operated on a hard, stable surface. This will prevent obstruction of the bottom chassis ventilation openings. Any obstruction of these openings could result in a possible over-heating condition. Do not attempt to remove or tamper with the rubber feet located on the bottom of the unit.

5.2 Inserting/Removing Light Guide

5.2.1 Ensure the power is not connected to the X-Cite® *exacte* unit.

5.2.2 Ensure that the protective end caps are removed from both the input and output ends of the light guide prior to installation.

5.2.3 Remove plastic plug (if present) from the light guide port on the front panel of the X-Cite® *exacte*.

5.2.4 Holding the light guide by the grey sleeve and strain relief portion only, insert the light guide into the light guide port. Push the light guide in until it seats with a second positive "click" (up to the “A” line printed on the grey ferrule).

Note: *Never grip the light guide during installation or removal in a place other than the reinforced strain relief portion of the light guide.*

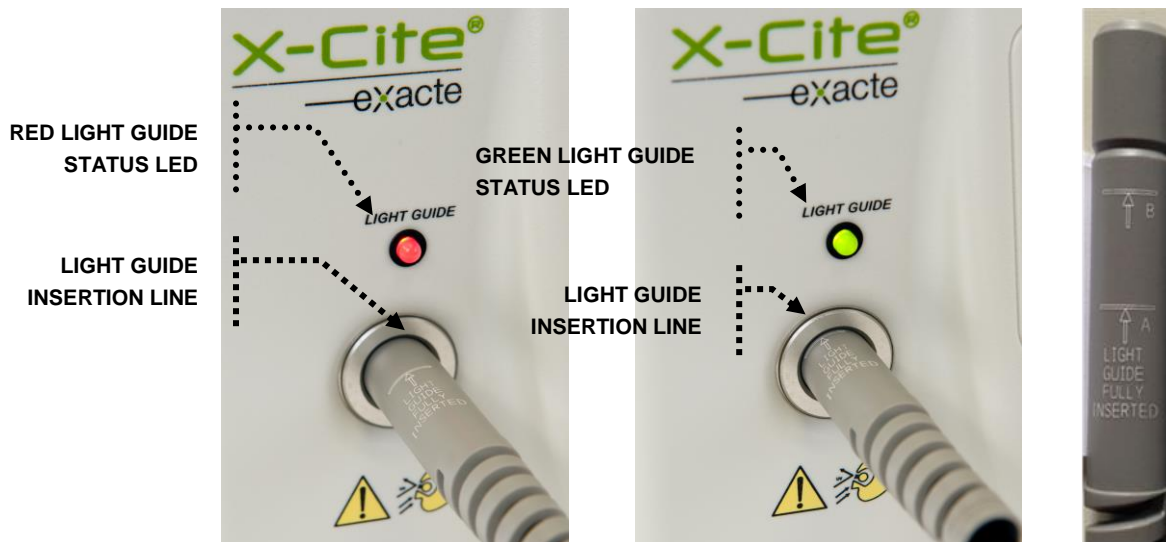

Figure 6 Light Guide Position

Tip: When the light guide is fully inserted, the line on the light guide insertion label will be right up against the light guide port. Also, the LED above the light guide port will illuminate green when POWER is on to the unit. If the light guide is not fully inserted the LED will illuminate red.

Note: The shutter will not open if the light guide is not fully inserted.

- 5.2.5 To remove the light guide, firmly grip the strain relief near the light guide retainer and pull out firmly.

Note: The X-Cite® exacte is designed for use with a 3mm liquid light guide. Excelitas Technologies can not guarantee the performance of the X-Cite® exacte if using light guides other than those supplied by Excelitas Technologies.

Note: The light guide has a minimum bend radius of 1.6 inches (40.0mm). Bending or coiling the light guide tighter than this radius will result in permanent damage to the light guide.



5.3 Tips to Prevent Premature Degradation of Light Guides

- 5.3.1 Liquid light guides have a typical useful life of 2-3 years in the X-Cite[®] *exacte* when installed and handled properly. The formation of bubbles is one of the most common reasons for a light guide to degrade prematurely and result in a sudden reduction in illumination intensity. Bubbles form without warning, usually due to overheating and/or mechanical stress to the light guide. Below are some simple tips to avoid overheating and stressing the light guide.
- 5.3.2 The light guide has a minimum bend radius of 1.6 inches (40.0mm). Bending or coiling the light guide tighter than this radius will result in permanent damage to the light guide.
- 5.3.3 Make sure the light guide is cooled properly during use, and prevent overheating:
- Always fully insert the light guide in to the X-Cite[®] unit; this ensures contact with a heat sink to conduct heat away from the light guide.
 - Never obstruct the air vents on the X-Cite[®] unit. Vents are located at the rear and underside of the unit.
 - Do not remove the rubber feet on the X-Cite[®] unit or otherwise reduce/block the space between the bottom of the unit and bench top. This may compromise airflow through the unit.
 - Ensure that the air being used to ventilate the X-Cite[®] unit is approximately “room temperature” (e.g. do not place the X-Cite[®] unit on top of another heat-producing instrument).
 - If a heated environmental chamber is being used for live cell imaging, make sure that the X-Cite[®] unit and the light guide are located outside of the chamber.
- 5.3.4 Do not expose the light guide to extreme temperatures (above 35°C, below -5°C) for extended periods of time during use, transport or storage; this may cause degradation of the seals and allow air bubbles to form in the liquid.
- 5.3.5 Never kink, bend, crush, or stretch the light guide; this type of mechanical stress may cause bubbles to form in the liquid and/or damage to the outer sheath
- Always allow adequate clearance between the light guide port of the X-Cite[®] unit and other objects to prevent excessive bending.
 - Place the X-Cite[®] unit close enough to the microscope so that there is some slack in the light guide and no sharp bends.

- 5.3.6 Never leave an endcap on the output end of the light guide when the other end is connected to the X-Cite[®] unit; if the unit is turned on in this condition, the cap will overheat, melt and/or permanently discolour the quartz end of the light guide.
- 5.3.7 While the X-Cite[®] unit is on but not in actual use (i.e. during sample preparation, or between time lapse time points) close the iris/shutter on the X-Cite[®]; this reduces unnecessary UV photon load on the liquid light guide. (Using only the shutter/stop in the microscope itself protects the specimen, but energy is still passing through the light guide.)

5.4 Installing the Collimating Adapter

- 5.4.1 Ensure that the power is off on the X-Cite[®] *exacte* unit.
- 5.4.2 The existing lamp housing must be removed from the microscope before the collimating adapter can be mounted. Do not discard the existing mounting hardware, since it will be used to secure the collimating adapter to the microscope.
- 5.4.3 Remove the collimating adapter from its packaging.

Note: *The collimating adapter has been set at the factory. No adjustments by the customer are required; however some adapter models are outfitted with centering set screws, for longer light path applications. Separate instructions are included with these models.*

- 5.4.4 Insert the flange portion of the collimating adapter into the lamp port of the microscope. Using the existing hardware, tighten the screw(s) until the flange is fully secured.

Note: *The installation of the collimating adapter will vary with microscope models.*

- 5.4.5 Remove the protective cap from the output end of the light guide. Insert the light guide into the input portion of the collimating adapter until it is flush with the adjustable insert. Secure the light guide to the collimating adapter by tightening the thumbscrew. Do not over tighten.

Note: *The light guide has a minimum bend radius of 1.6 inches (40.0mm). Bending or coiling the light guide tighter than this radius will result in permanent damage to the light guide.*

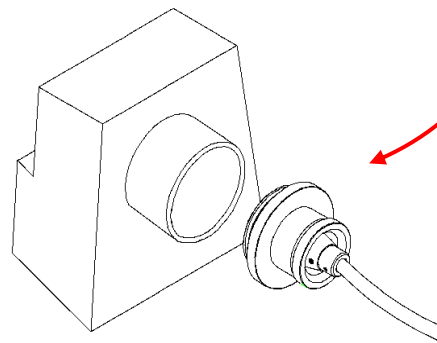

Figure 7 Collimating Adapter



Warning!

Turning power on to the X-Cite® *exacte* unit without the light guide properly installed in the unit and in the microscope can increase your risk of exposure to UV light.

6. Operation

6.1 Powering Up/Powering Down

Lamp Warm-Up:

The ARC lamp has 3 distinct phases of operation;

- 1. Ignition.*
- 2. Warm-up. **Excelitas Technologies recommends 20 minutes of proper warm-up and to ensure a stable optical output.***
- 3. Stable Operation.*

*It is recommended that phase 1 and 2 are not interrupted. This can result in shortened lamp life. **The lamp must be allowed to warm-up uninterrupted.***

6.1.1 Ensure that the lamp and light guide have been properly installed and that the lamp housing panel is securely fastened.

6.1.2 Plug the X-Cite® exacte unit into a properly grounded AC outlet.

Warning! Turning power on to the X-Cite® exacte unit without the light guide properly installed in the unit and in the microscope can increase your risk of exposure to UV light.

6.1.3 Turn on the main POWER switch “I”, located on the front panel and check the fan for airflow.

6.1.4 As soon as the LED display turns on, it will display the version of software currently programmed in the unit (*i.e.* R – X). Once the software version level has been indicated, the display will reset after several seconds to the next display mode.

6.1.5 The lamp will automatically turn on within 45 seconds and the LAMP indicator will illuminate. The display will flash during the warm up period for approximately 4 minutes. The display will stop flashing when the warm up period has completed. Wait until the warm up period has completed before using the unit to illuminate a specimen. **Excelitas Technologies recommends 20 minutes to ensure a stable output**

Note: Unit should not be turned off unless the lamp has been on for a minimum of twenty minutes.

6.1.6 To power down the unit after use, set the main power located on the front panel to “0”.

Note: *If the lamp is turned off, and an attempt is made to turn it back on before it has fully cooled, the “cool” message will appear on the display. The lamp will automatically re-strike when the lamp has cooled.*

6.2 Quick Start: Illuminating a Specimen

6.2.1 When the X-Cite® *exacte* is first powered on, the internal shutter will be in the closed position as a safety precaution and the iris will be in the 0% position.

6.2.2 To illuminate a specimen, press and release the **SHUTTER** button to open the shutter (**OPEN LED** will turn on).

6.2.3 Use **UP/DOWN** buttons to adjust intensity to desired level. (See [section 6.6](#) and [6.7](#) for additional information on intensity modes and adjustment).

6.3 Front Panel Button Functions

Button	Condition	Description
SHUTTER	Press and release	Opens/closes internal shutter
MODE	Press and release within 1 second	Cycles between COARSE, FINE and HOURS mode
	Press and release after 1 second	Toggle between relative intensity and absolute power display modes (if unit is calibrated)
	Press and release during audible alarm	Silences audible alarm
UP	Press and release	Increases intensity by 1 step
	Press and hold	Increases intensity continuously
DOWN	Press and release	Decreases intensity by 1 step
	Press and hold	Decreases intensity continuously
MODE + UP	Hold MODE down, press and release UP (i.e. treat MODE like a “shift” key)	Engage/disengage Closed-Loop Feedback mode; disables UP/DOWN buttons from being used to adjust intensity

6.4 LED Indicators

LED Indicator	Status	Description
LIGHT GUIDE	On – Green	The light guide is fully inserted
	On – Red	The light guide is not fully inserted
LAMP	On	The lamp is on
	Off	The lamp is off
OPEN	On	The shutter is open
	Off	The shutter is closed
COARSE	On	The unit is in coarse adjustment mode; LED display indicates current intensity setting
FINE	On	The unit is in fine adjustment mode; LED display indicates current intensity setting
HOURS	On	The unit is in lamp hours mode; LED display indicates accumulated lamp hours
CAL	On	The X-Cite® <i>exacte</i> has been successfully calibrated with Radiometer or Power Meter
	Off	The X-Cite® <i>exacte</i> is not calibrated
	Blinking	Calibration will expire within 12 hours
Closed-Loop Feedback	On	Closed-Loop Feedback is engaged
	Off	Closed-Loop Feedback is not engaged

6.5 Display Format Reference

6.5.1 The formatting used on the display board is used to identify the unit of measurement (% , watts, Hours) of the value.

Display Format	Definition	Description
XXX	Intensity Setting (%)	Displays the iris setting, which gives relative intensity as percentage of the lamp's maximum output
XX.XX	Power Setting (watts)	Displays the power setting, which gives absolute intensity in terms of watts
uXXX	Power Setting (microwatts)	Displays the power setting, which gives absolute intensity in terms of microwatts
X.XXX or XXX.X	Power Setting (milliwatts)	Displays the power setting, which gives absolute intensity in terms of milliwatts
XXXX.	Lamp Hours	Displays the "hours of use" accumulated by the lamp
Flashing: "XXXX"	Warming Up	The lamp is warming up. Warm up time is approximately 4 minutes

6.6 Output Intensity Modes

- 6.6.1 The X-Cite® *exacte* can be operated in two different output modes: *Relative* and *Absolute*.

Relative Mode:

Intensity level is adjusted and displayed as a percentage of the lamp's current maximum output. When operating in relative mode, intensity is displayed using three digits ("XXX") on the display screen.

Absolute Mode:

Intensity level is calibrated in watts, and can be adjusted and displayed in terms of the actual output power in watts. When operated in absolute mode, intensity is displayed using four digits with a decimal point ("XX.XX", "uXXX", "X.XXX", or "XXX.X") on the display screen. Formatting of the digits will indicate whether units are watts, milliwatts, microwatts. Scale will auto adjust as appropriate.

NOTE: Absolute Mode is only accessible only when the X-Cite® *exacte* has been calibrated with an X-Cite® Radiometer or X-Cite® Power Meter (see [section 7](#)) and the **CAL** LED on the front panel is on.

- 6.6.2 To toggle between Relative and Absolute intensity modes in a calibrated system: Ensure that the display is showing an intensity value (i.e. not in Lamp Hours Mode).
- 6.6.3 Press **MODE** and release *after* 1 second.

NOTE: Some rounding may occur when toggling between relative and absolute display modes, unless the iris setting is a multiple of 5% (the calibration points).

6.7 Adjusting Light Output

- 6.7.1 The X-Cite® *exacte* includes an iris to adjust the level of illumination. Adjustments can be made in increments as small as 1% of maximum output. Since there are 100 individual intensity steps, for convenience, there is the option of adjusting in either COARSE or FINE mode.
- 6.7.2 Press the **MODE** button to select either the COARSE or FINE mode, which will be indicated by the LED's to the right of the display.

- 6.7.3 Use the **UP** and **DOWN** buttons to step through the intensity settings. Size (and unit) of the step depends on whether the unit is operating in relative or absolute mode.

	Step Size in RELATIVE Mode	Step Size in ABSOLUTE Mode
COARSE	10%	Value in watts corresponding to 10%
FINE	1%	0.01 W

6.8 Viewing Accumulated Lamp Hours

- 6.8.1 The X-Cite® *exacte* system automatically accumulates the number of hours for which the lamp has been on, and shows this information on the LED display. The lamp hours are shown when the unit is in Lamp Hour mode.
- 6.8.2 To put the X-Cite® *exacte* in Lamp Hour Mode, press the **MODE** button until the **HRS** LED on the front panel is illuminated. The LED display will show four digits with a flashing decimal point at the end (“XXXX.”). The number shown here will be the total number of hours the lamp has been in operation.

6.9 Closed-Loop Feedback™ (CLF)

- 6.9.1 The X-Cite® *exacte* is equipped with Closed-Loop Feedback™ (CLF) control to ensure that from the beginning to the end of an experiment, the illumination level remains constant. When CLF is enabled, the system will automatically compensate for any fluctuation or degradation in light intensity by adjusting the iris position. For best results, allow the lamp to warm up and stabilize to its normal operating temperature, about 30 minutes.
- 6.9.2 To enable CLF: Set the intensity to the desired level. Press and hold the **MODE** button, then press and release the **UP** button. The CLF light will turn on. (Note: **UP** must be released before **MODE**—treat **MODE** like a “shift” key).
- 6.9.3 To disable CLF: Press and hold the **MODE** button, then press and release the **UP** button. The CLF light will turn off.
- 6.9.4 Even over several days, the output power will be maintained within $\pm 2\%$ of the set point. (Set point = the output level at which CLF is enabled.) For verification of the actual output power, the variance from setpoint can be logged over time and exported as a data file (see [section 9](#) for additional information).

Important Notes about CLF

Since CLF uses the iris to make adjustments to output power, CLF cannot be used if iris position is 100% open. Similarly, if the initial set point is 95%, and over a continuous multi-day experiment the iris needs to be opened to 100% to

maintain constant intensity, CLF will not be able to compensate for further drops in power.

Warning signals while CLF is engaged:

1. If the iris reaches 95% open or more, the **CLF** LED will start to blink.
2. If the iris reaches 100% open, the **CLF** LED will blink and alarm will beep until CLF is disengaged.

NOTE: If setting CLF while in absolute power mode (display in watts), check the actual iris setting first to be sure that there is room for output adjustments to be made.

What will the display show when CLF is engaged?

In Relative Mode: Actual iris position (i.e. value will update as iris is adjusted in CLF)

In Absolute Mode: Output power (i.e. value will not change, since this is the set point)

NOTE: The intensity setting cannot be changed while CLF is engaged, however, the **MODE** button can be used as usual to toggle between display modes to view hours, iris position and power set point.

7. Calibration/Radiometry (optional)

All X-Cite® *exacte* units are capable of being calibrated with an X-Cite® Power Meter XR2100 or X-Cite® Radiometer XR2000 (optional accessories). Once calibrated, the lamp output can be set in absolute units (watts), for easily repeatable illumination levels.

For convenience, the basic instructions for using the X-Cite® Power Meter XR2100 or X-Cite® Radiometer XR2000 with the X-Cite® *exacte* are provided here. For full instructions and safety information, refer to the complete Optical Power Measurement System User's Guide (035-00390R) or Radiometer XR2000 User Guide (035-00285).

Important Buttons and Settings (underlined settings are recommended for use in microscopy):

- **RELATIVE/ABSOLUTE** – toggles between readings in % (relative) and watts (absolute).
- **POWER/IRRAD** – toggles between readings in W (power) and W/cm² (irradiance); scale will adjust between W and mW automatically (XR2000 only)
- **X-CITE® CAL** – initiates calibration sequence

7.1 X-Cite® *exacte* Power Reading using the XR2100 Power Meter or XR2000;

1. Set the X-Cite® *exacte* to the desired intensity.
2. Close X-Cite® *exacte* shutter using **SHUTTER** button.
3. Remove light guide from microscope adapter
4. Snap the 3mm (red) light guide adapter into the top of XR2100 (if not already in place).
5. Loosen thumb screw on red light guide adapter, fully insert and fasten light guide into holder.
6. Turn XR2100 on using the **ON** button
7. Open X-Cite® *exacte* shutter, the power reading will show on the display.

7.2 X-Cite[®] *exacte* Calibration using the XR2100 (or XR2000) & Light Guide

- 7.2.1 Set up the XR2100 to obtain a power reading through the light guide input port. Refer to [section 7.1](#) or user guide 035-00390R.
- 7.2.2 Attach the Stereo Connection Cable to the port on the right side of the XR2100 (under flap in rubber boot), and the port on the right side of the X-Cite[®] *exacte*.
- 7.2.3 Press and release the X-Cite[®] *exacte* CAL button on the XR2100.
- 7.2.4 The X-Cite[®] *exacte* will display CAL, and the XR2100 will display a moving dash (–) while the calibration sequence is running.
- 7.2.5 When the calibration is complete, the CAL LED on the X-Cite[®] *exacte* will light up, and the X-Cite[®] *exacte* will display intensity settings in the format XX.XX (in watts).
- 7.2.6 For versions 2.0 and up: X.XXX or XXX.X for milliwatts and uXXX for microwatts.



WARNING: *Do not remove the light guide from the Power Meter until calibration sequence is complete. While calibrating, the shutter will automatically open and close under the control of the power meter.*

7.3 Calibrating X-Cite[®] *exacte* with the Objective Plane Power Sensor, XP750

- 7.3.1 For convenience, the basic instructions for using the Objective Plane Power Sensor with the X-Cite[®] *exacte* are provided here. For full instructions and safety information, refer to the complete Optical Power Measurement System User's Guide (035-00390R).
- 7.3.2 Leave the X-Cite[®] *exacte* light guide connected to your microscope as you would during normal operation. Keep the X-Cite[®] *exacte* positioned as you would during normal operation.
- 7.3.3 Place the XP750 onto your microscope as described in user guide 035-00390R, and connect it to an XR2100.
- 7.3.4 Attach the Stereo Connection Cable to the port on the right side of the XR2100 (under flap in rubber boot), and the port on the right side of the X-Cite[®] *exacte*.
- 7.3.5 **IMPORTANT:** The XP750 will calibrate X-Cite[®] *exacte* using data from only one wavelength setting. It is important to select the wavelength most applicable to your application prior to calibrating the X-Cite[®] *exacte* using the system. The ideal wavelength setting is dependent on your application and typically corresponds to the excitation maxima (peak) of the fluorophore. Please refer to

user guide 035-00390R, for setting the wavelength being measured by the system.

- 7.3.6 Press the X-Cite® **CAL** button on the XR2100 to perform an XP750 calibration.
- 7.3.7 The X-Cite® *exacte* will display CAL, and the XR2100 will display a moving dash (–) while the calibration sequence is running
- 7.3.8 When the calibration is complete, the CAL LED on the X-Cite® *exacte* will light up, and the X-Cite® *exacte* will display intensity settings in the format XX.XX (in watts), X.XXX OR XXX.X for milliwatts and uXXX for microwatts.
- 7.3.9 X-Cite® *exacte* internal software version 2.0 or higher is required to display the lower power measurements from XP750 calibration. Software version is displayed during X-Cite® *exacte* start-up sequence. Contact Excelitas Technologies if a software upgrade is required.

Note: the shutter will be in the closed position when the calibration routine is complete.

7.4 To Clear a Calibration

The X-Cite® *exacte* calibration will automatically be cleared under any of the following circumstances:

1. The light guide is pulled out.
2. The lamp module is replaced.
3. The calibration has been in use for more than 100 hours.

NOTES:

1. For best results, allow the lamp to run at least 30 minutes before running a new calibration. As the lamp heats up and the internal burner pressure changes, lamp output will also change. For a calibration to be accurate, the lamp should be at its normal operating temperature.
2. The number of bends in the light guide, as well as their bend radii, can have an effect on light transmission. For best results, maintain the same light guide configuration/shape that is present during normal use should be used when calibrating. If equipment is rearranged, verify (or redo) the calibration.
3. Calibrations are typically valid for 100 hours of use. If the lamp is fairly new (ie it has <300 hours logged) recalibrating more often is recommended, since the lamp goes through the most dramatic changes in output during this period.
4. If in doubt:
 - a. Measure the output power with the Power Meter or Radiometer and compare to the calibrated value on the display.
 - b. Recalibrate the unit prior to any critical experiment.

8. Warnings and Alarms

The X-Cite® *exacte* is designed to detect certain conditions that may affect safe or proper functioning. These conditions are categorized as one of three “alarm types” according to the danger they pose to the operator, system or experiment:

1. Critical Safety – continuing may cause harm to the operator or equipment, alarm shall not be clearable until “Alarm Condition” is corrected
2. Function – operation may continue, but depending on specific alarm condition, functionality of unit may be limited or impossible (e.g. lamp too hot to strike)
3. Warning – warning only, operation may continue as normal

Alarm Condition	Alarm	Type	Other Actions/ Corrections
Light guide is not inserted properly and/or removed while shutter is open or an attempt is made to open the shutter	LIGHT GUIDE LED turns red, “3 beep” audible alarm	Critical Safety	Shutter shall automatically close and be disabled from opening until light guide is inserted
CLF is engaged with iris open at 95% or higher (i.e. limited ability to compensate for degradation)	Blinking CLF LED	Warning	
CLF is engaged and iris has reached 100% open	Audible beeping, blinking CLF LED	Function	Operation in non-CLF mode will continue
End of calibration period approaching (e.g. 12 hours left)	blinking CAL LED	Warning	
Calibration has expired	CAL LED turned off	Function	Continue operating in relative intensity mode
Lamp failure to strike	Display “BULB”	Function	
Lamp too hot to strike	Display “COOL”	Function	Automatically attempt to re-strike lamp when cool
Shutter failure	Audible beeping, display “SF1”	Critical Safety	If failure to close—turn off lamp
Lamp overheated	Display “E1”	Critical Safety	Turn off lamp
Lamp self-extinguish or non-passive failure	Display “E6”	Critical Safety	Fan/blower shall shut off

8.1 Clearing Alarms

8.1.1 The X-Cite[®] *exacte* provides an audible alarm to alert the operator of various error conditions.

8.1.2 To silence the audible alarm:

1. Manually: Press the front panel **MODE** button
2. Remotely:
 - a. From the Graphical User Interface (GUI), by clicking the “Alarm” icon.
 - b. From a PC through I/O port when the “aa\r” command is sent to the X-Cite[®] *exacte*.

9. External Control

9.1 Graphical User Interface (GUI)

9.1.1 A Graphical User Interface (GUI) for use with the X-Cite[®] *exacte* is available online (Control Panel Software: <http://www.excelitas.com/Pages/Product/X-Cite-exacte.aspx>). This interface will:

1. Permit computer control of all functions normally available with the front panel buttons
2. Identify any alarm condition by changing the colour of the corresponding icon
3. Display and record: real-time intensity data from the X-Cite[®] in terms of % variance from the set-point, system parameter changes, user-defined events

9.2 Installation:

Note: This procedure will install both the GUI and the virtual COM port driver.

1. Unzip files and save to a folder on your computer.
2. Double-click the file **setup.exe** within that folder.
3. Follow set-up wizard instructions.
4. Connect the X-Cite[®] *exacte* to the USB port of your computer.
5. The new hardware found wizard will appear, select **No** to search windows update for the software. Click Next to continue.
6. Select **Install from a list or specific location (Advanced)** to locate the driver and click Next.
7. Check off **Include this location in the search:** and browse to the location on your hard drive where you unzipped the files to in step 1. Click Next.
8. The X-Cite[®] *exacte* has a virtual COM port for support of the X-Cite[®] 120PC communication protocol. Another piece of hardware will be detected, follow steps 5-7 again.
9. When set-up is complete, the X-Cite[®] *exacte* icon will automatically appear on computer desktop.

9.3 Graphical User Interface Panel

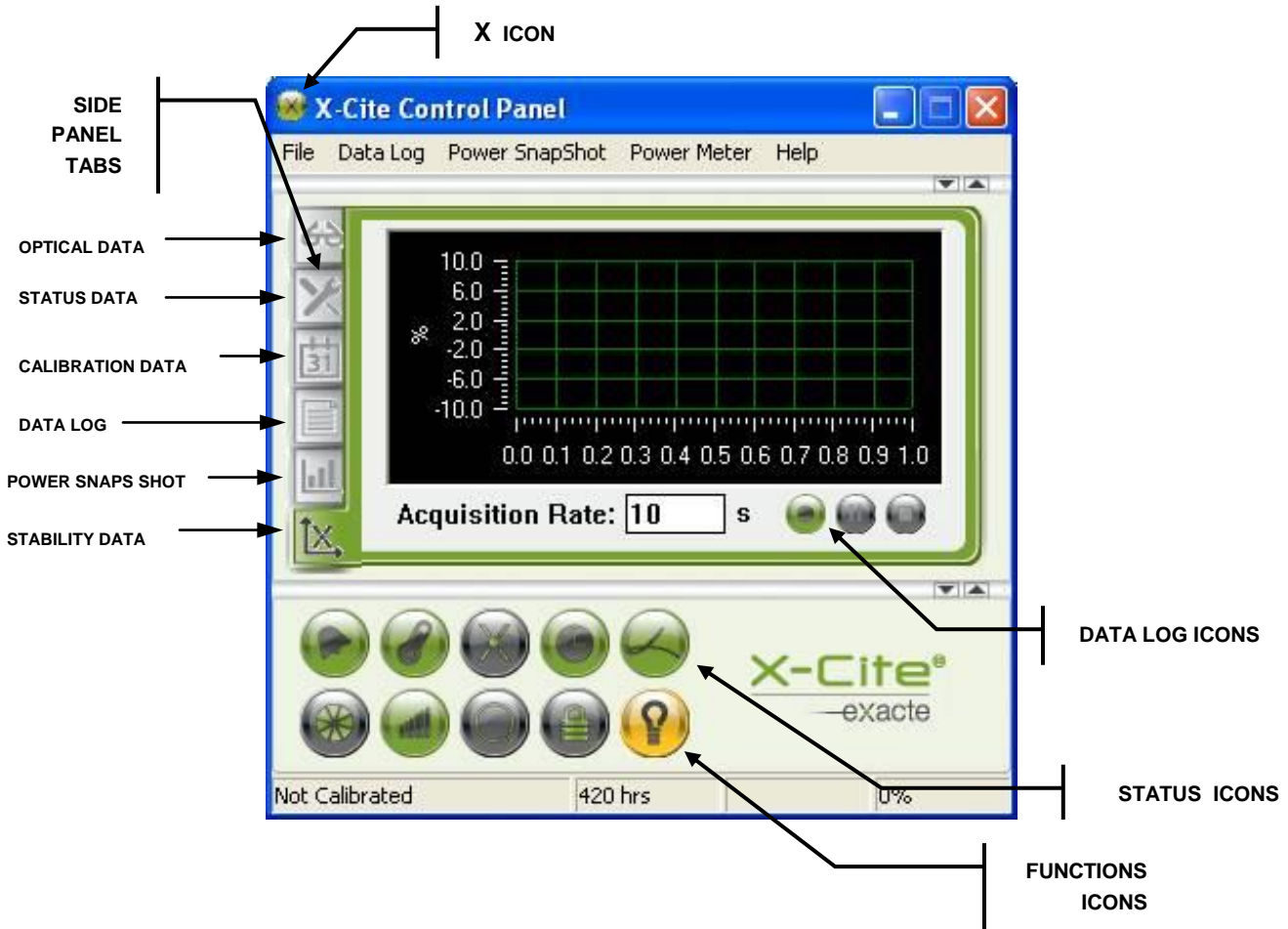















Figure 8 GUI Control Panel

9.4 Icons and Functions:

ICON	NAME	DESCRIPTION
	Alarm	Indicates an alarm state Click to silence audible alarm Red = Alarm on
	Temperature	Indicates lamp temperature status Yellow = Lamp running hot Red = Lamp off, excessive heat
	Calibration	Indicates calibration status Green = Calibrated Grey = not Calibrated
	Lamp Hours	Indicates hours logged on lamp green < 2500 hours, yellow = > 2500 hours, make sure there is a spare lamp on hand red = > 4000 hours, lamp is off due to age.
	Light Guide	Indicates light guide position Green = Light guide present Red = Light guide not present
	Shutter	Click to open/close shutter [note: lock front panel to use, see note #2 below]
	Intensity	Left mouse click = increase by 1% increment. Right mouse click = decrease by 1% increment. Left double click mouse = dialog box enabling data input of desired intensity or power.
	Closed-Loop Feedback	Engage/disengage CLF mode Grey = OFF Green = ON, if clicked ON intensity will freeze, click again to turn off.
	Lock/unlock	Lock/unlock the front panel controls on the unit Green = front panel of X-Cite [®] <i>exacte</i> locked Grey = front panel of X-Cite [®] <i>exacte</i> unlocked, Shutter will not activate from the control panel if the front panel is not locked.
	Lamp	Click to turn lamp on/off, color indicates status Green = ON, click to turn lamp on Grey = OFF, click to turn lamp off Yellow = Warming Up, lamp is on and is warming up.
	Record	Record CLF data on graph [% variance from set point]
	Pause	Pause recording data
	Stop	Stop recording data
	Plot/Event	Left-click on graph area to log an event

Notes:

- Icon background colour code:
 - Green icons mean status is OK and/or the function is engaged
 - Yellow icons mean a warning, or that the system is getting ready
 - Red icons mean there is an alarm condition

2. Shutter control with GUI vs. front panel buttons: The internal shutter can be operated using either method, however for the unit to accurately monitor shutter status only one method should be used at a time. If the front panel is “unlocked” the unit assumes the front panel shutter button will be used and the shutter icon on the GUI is disabled. If the front panel is “locked” the system assumes that the GUI control will be used and the front panel shutter button is disabled.
3. When icons are **ALL** grey, the X-Cite® *exacte* is either disconnected or not communicating properly with the computer
4. Side Panel Tabs shown greyed-out in Figure 8 GUI Control Panel will not be operational unless the X-Cite® Optical Power Measurement System is connected. Refer to X-Cite® Optical Power Measurement System User Guide 035-00390R for instructions.
5. GUI Control Panel is collapsed in view below.

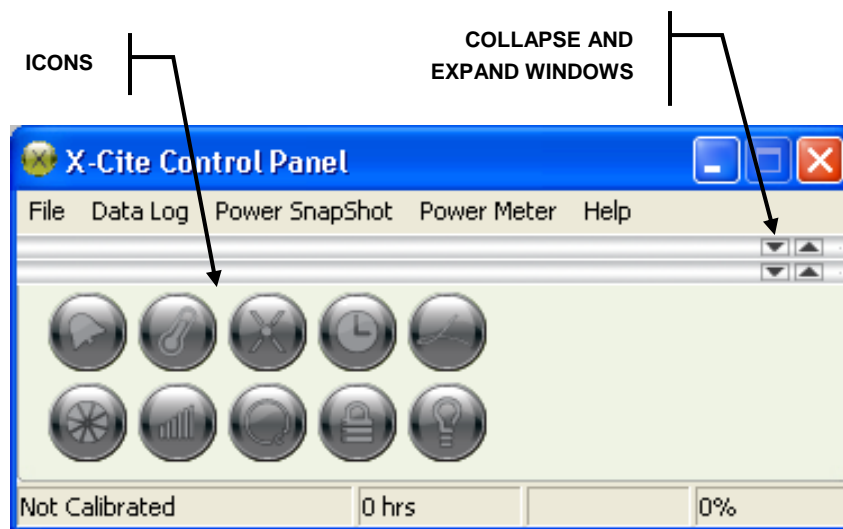

9.5 Logging Stability Data

- 9.5.1 When in CLF mode, the signal from the feedback loop can be recorded as verification that the set-point is being maintained. Simply open the “Stability Data” tab and click on the “Record” icon to start logging data. New data points will be added every 10 seconds (or longer if acquisition interval is increased). The default 10 seconds is the shortest interval available. On the plot area, the x-axis is in minutes, y-axis is in % variance from the set point.

9.6 Logging Events

- 9.6.1 The Control Panel will automatically log events such as alarm conditions, calibration expiry, and CLF turning off. User-defined events or information relating to the X-Cite[®] set-point, or experimental conditions can also be logged in the data file. To log an event:

1. Left-click on the plot area.
2. Type in the event or information, up to 100 characters.
3. Click OK. The information will be logged in the data file for the time point when the dialogue box first opened (even if it takes several time points to type in the information).

9.7 Exporting Logged Data

- 9.7.1 To export logged data...
1. Click on the X icon in the title bar.
 2. From the drop down menu, choose “**Export Data...**”
 3. Give the file a name, click SAVE - data will be saved in Comma Separated Values (.csv) format, which can be opened in Excel.

9.8 Shutter Control via Foot pedal

9.8.1 For hands-free operation, the X-Cite[®] *exacte* is equipped with a foot pedal. The foot pedal is an alternative to the SHUTTER button and can only be used to open and close the internal shutter. To use the foot pedal:

1. Plug the foot pedal into the 3.5mm audio style port labelled FP on the back on the X-Cite[®] *exacte*.
2. Place the foot pedal on the floor or another conveniently located flat surface.
3. Power-up the X-Cite[®] *exacte* as normal, and wait for the lamp to warm up.
4. Press down on the foot pedal until it clicks to open or close the shutter.

9.9 Shutter control via TTL

9.9.1 For high-speed shutter activation, TTL control can also be used. The plot below shows typical timing values for the X-Cite[®] *exacte* internal shutter when controlled by TTL. Note that these values should be used as a guide only, and that actual values will vary slightly from unit to unit.

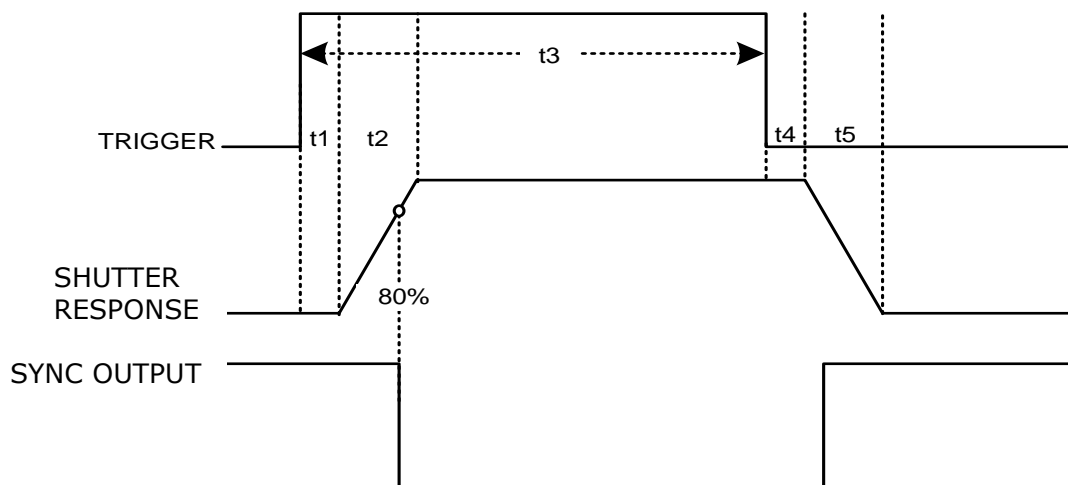

Interval	Description	Time (milliseconds)
t1	Delay time, trigger to start of opening	4
t2	Start of opening to 100% open	2
t3	Minimum recommended exposure time (trigger open to trigger closed)	40
t4	Delay time, trigger to start of close	4
t5	Start of close to 0% open	2

Note: Using values of $t3 < 40\text{ms}$ may result in shutter bounce-back and a brief unintentional exposure period.

TTL Signal and Shutter Status

TTL	Shutter	Sync
high	open	low
low	closed	high

TTL INPUT (BNC)

Maximum low-level +0.8VDC
Minimum high-level +2.0VDC
Maximum high-level +5.5VDC
Typical input current: 800uA

SYNC OUT (BNC)

Maximum low-level +0.8VDC
Minimum high-level +4.5VDC
Maximum output current: 500uA

9.10 Software Developer's Kit (SDK)

The command list for X-Cite® *exacte* is available by request. To obtain the latest update, please contact Excelitas Technologies.

10. Troubleshooting

Service to be completed by qualified repair personnel only!



10.1 Error Codes

If the X-Cite® *exacte internal* monitoring systems identify a problem, an error code will be generated. Definitions and recommended actions are in the following table.

Code	Error Description	Recommended Action
E1	Lamp temperature is too high	Check ventilation filters and outlets to ensure that no blockage exists. Restart unit and if problem persists replace lamp. If problem continues contact Tech Support . See also section 10.7
E2	Internal communication failure	Restart unit, if problem persists contact Tech Support .
E3	Iris failed to go to home position	Restart unit, if problem persists contact Tech Support
E4	Internal hardware failure	Restart unit, if problem persists contact Tech Support
E5	Failure to communicate with Intelli-Lamp	Check Intelli-Lamp connection and restart unit. If problem persists try another lamp, if problem still persist contact Tech Support .
E6	Lamp self-extinguished	Let system cool and restart lamp. If it goes out again, replace lamp. If new lamp continues to self-extinguish, contact Tech Support
E7	Internal system error	Restart unit, if problem persists contact Tech Support
bulb	Lamp Error	Lamp installed incorrectly / Lamp did not strike.
cool	Lamp is too hot to strike	The lamp will automatically strike when it has cooled to the optimum striking temperature
Alternating: old / bulb	Old Lamp	The lamp has accumulated over 2500 hours. Lamp may be near end of life.
Alternating: end / bulb	New Lamp Required	The lamp has reached end of life. The lamp will not strike.
LOC	Front Panel Locked	All front panel buttons have been locked to prevent settings from being changed.
SFI	Shutter Failure	The shutter has failed to return to home position. Unit should be restarted. If the error repeats, contact Tech Support .

10.2 Power Up Failure

If the unit fails to POWER up or function properly, use the following checklist to eliminate the most common causes of problems. Check that:

1. The AC POWER cord is securely plugged into a functional AC wall plug.
2. The AC POWER cord is securely plugged into the AC inlet on the rear of the unit.
3. The main AC POWER switch is in the ON position.
4. Check that the ventilation openings on both the bottom and rear of the unit are not blocked.

If the unit still does not power-up:



5. Check both main power fuses by first disconnecting the power cord. Then carefully remove the fuse drawer assembly below the AC inlet on the rear of the unit. If the fuse(s) is/ are open, replace with the same type (4A, 250 V, Fast acting).

10.3 Lamp Strike Failure

If the LED display lights and the fan starts, but the lamp will not turn on, check for the following:

1. The LED display indicates the “**bulb**” message and the system begins to beep. This indicates that no lamp is detected. Check if the lamp has been installed correctly. Refer to Section 5.1– Installing the Lamp Module.
2. The LED display indicates the “**bulb**” message after approximately 45 seconds and the system begins to beep. This indicates that the lamp has failed to strike. It may be a result of the lamp reaching end of life, or that the lamp housing panel is not secured properly in place. Press the MODE button to clear the audible alarm. Turn power off to the unit. Check that the lamp housing panel is secured properly. Wait a few minutes and turn the power on to the unit. If it still does not strike, replace the lamp.
3. The LED display indicates the “**cool**” message. This indicates the lamp is too hot to strike. The lamp will automatically strike when it has cooled.

10.4 Low Light Intensity

If the light intensity is too low, check that:

1. The percent iris opening is set high enough. Put the unit into COARSE Mode and press the UP button to increase the iris opening. See Section 6.7– Adjusting the Light Output.
2. There are no foreign substances on the emitting end of the light guide.
3. There are no bends, kinks, or other physical damage to the guide. Replace the light guide if there is any physical damage.
4. The lamp has been installed correctly. See section 5.1– Installing the Lamp Module.
5. Check the microscope settings, filter cubes, ND filters, manual stops, polarisers, and position of camera port beam splitters for anything that may be blocking the light path between the X-Cite® and eyepieces/camera.

It may be necessary to replace the lamp or to replace the light guide. [Contact your Excelitas Technologies sales representative](#) for information on purchasing a new lamp or light guide.

10.5 Shutter Failure

If the shutter does not open, check that:

1. The light guide is fully inserted; the LED above the light guide port will be illuminated green. The lamp is warmed-up; the display is not flashing. The iris setting is not at 0%. **Note:** If the GUI is in use, ensure that the front panel of the unit is “unlocked” when attempting to use the SHUTTER button.
2. If the LED displays “SF1”, indicating a shutter failure. POWER down the unit, wait a few minutes and turn POWER on to the unit. If the unit displays a shutter failure again, contact your local [Excelitas Technologies Service Center](#) to have your unit serviced.

10.6 LED Display Failure

If the LED display does not light:

1. If the fan is functional, POWER down the unit, wait approximately 20 seconds then POWER it up again
2. If the problem persists, contact your local [Excelitas Technologies Service Center](#).

10.7 Cooling Fan Failure

If one or more fans do not work:

1. If the LED display is functional, POWER down the unit, wait approximately 20 seconds then POWER it up again
2. If the problem persists, contact your local [Excelitas Technologies Service Center](#).

11. Care and Maintenance

Note: Unless otherwise specified, information in this section applies to all X-Cite® arc lamp illuminators, regardless of which model may be depicted

11.1 General

11.1.1 This section contains installation, maintenance and troubleshooting tips to help optimize the lifetime and performance of X-Cite® *exacte* units and components. This information is intended to supplement the detailed installation and operating instructions found in the X-Cite® User Manuals. Topics covered include liquid light guides, lamps, and air vents – the components most likely to affect performance over time and require maintenance or replacement. Note that the lifetime information on components is for typical or average conditions. Depending on the imaging application, more frequent replacement may be required—for example, if a fluorophore’s signal is low to begin with, or is excited by a low power portion of the X-Cite® lamp’s output spectrum.



11.1.2 Operate the unit in a well ventilated area with at least six inches clearance at the rear of the unit for proper air flow. Do not place any objects below the unit, between the feet as this will restrict airflow through the bottom of the front face plate.

11.1.3 For safe operation, use only a grounded outlet.

11.1.4 Avoid physical shocks or jarring to the unit especially while the unit is operating. Such sudden movements reduce the lamp module life.

11.1.5 The lamp module must be operated for a minimum of 20 minutes each time it is turned on to prevent damaging the lamp. Increasing the time between turning the lamp module on and off will maximize lamp life.



11.1.6 Replace the air filter, found under the front face plate, frequently to ensure unrestricted air flow. It is recommended as a minimum that the air filter be replaced every time the lamp module is replaced.

Note: *restricted airflow can cause the lamp temperature to increase above optimum temperature, significantly reducing lamp life.*

11.1.7 When necessary, clean the light emitting end of the light guide using an optical cleaning solution.

11.1.8 Cleaning of unit is not required, however if cleaning is desired, disconnect the AC power cord from the unit and use only a water and simple detergent solution. Ensure that cleaning solution does not come in contact with any optical, moving mechanical or electrical parts.

11.2 Liquid Light Guides

Proper handling and installation of liquid light guides

11.2.1 Liquid light guides have a typical useful life of 4000 hours of operation when handled properly and installed in a well maintained X-Cite® *exacte*. The formation of bubbles is one of the most common reasons for a light guide to degrade prematurely and result in a sudden reduction in illumination intensity. Bubbles can form without warning, and if they occur within the first 1500 to 2000 hours of use, is it typically due to overheating and/or mechanical stress to the light guide. Below are some simple tips to avoid overheating and stressing the light guide.

11.2.2 Always fully insert the light guide in to the X-Cite® unit (i.e. up to the “A” line printed on the grey ferrule); this ensures contact with a heat sink to conduct heat away from the light guide.

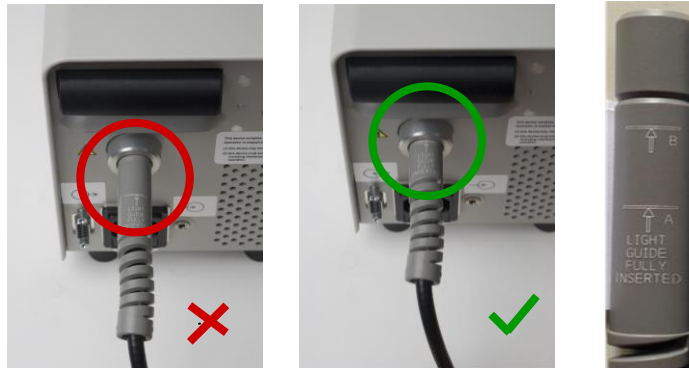

11.2.3 Always allow adequate clearance at the rear of the X-Cite® unit and microscope to prevent excessive bending and/or crushing of the light guide against walls. Minimum bend radius to prevent immediate damage to the LLG is 40mm, however, a bend radius of at least 75mm is recommended for a light guide while “in use”. Sharper bends can cause heat to build up and cause problems longer term.

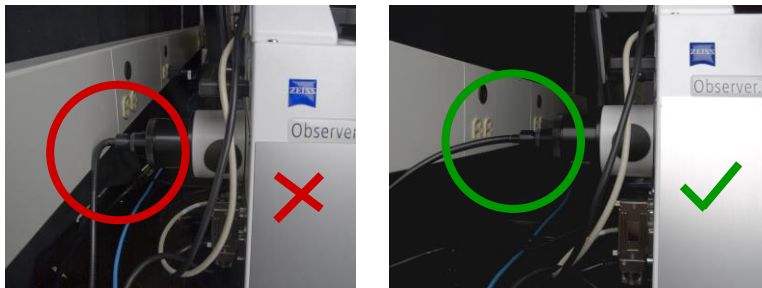

11.2.4 Always place the X-Cite® unit close enough to the microscope so that there is some slack in the light guide and no sharp bends.

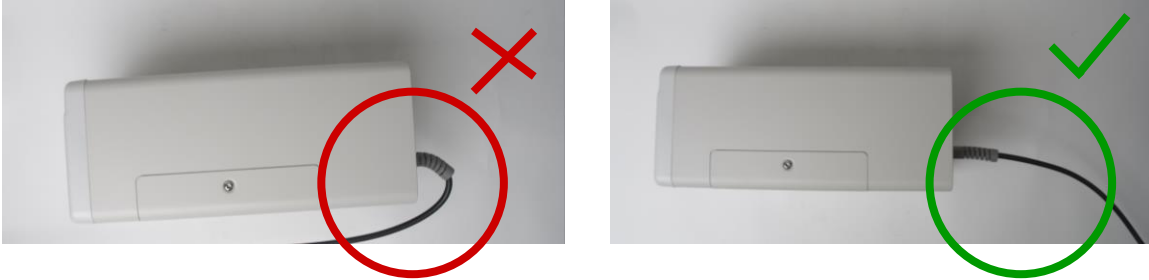

11.2.5 Never leave an endcap on the output end of the light guide when the other end is connected to the X-Cite® unit; if the unit is turned on in this condition, the cap will overheat, melt and/or permanently discolour the quartz end of the light guide.

11.2.6 Do not expose the light guide to extreme temperatures (above 35°C, below -5°C) for extended periods of time during use, transport or storage; this may cause degradation of the seals and allow air bubbles to form in the liquid.

What does a bubble look like?

11.2.7 Depending on the size and location in the light guide, a bubble may or may not be obvious. To check for bubbles:

11.2.8 Disconnect the LLG from the X-Cite® and microscope adapter.

11.2.9 Hold one end towards a bright window or overhead room light - DO NOT use an X-Cite® or any other focused light source for this test!

11.2.10 Look at the quartz at the other end of the LLG

- a. Bubble-free: quartz end will appear as a bright, solid circle; you may also be able to see a thin circular outline at the quartz/liquid interface.
- b. Bubbles at/near the quartz end: appear as dark spots, as small as 0.5mm in diameter or even as larger more defined spheres.
- c. Bubbles in the middle of the light guide: may not be well-defined spots, but will appear as dark shadows
- d. In extreme cases, where the bubble is blocking the entire diameter of the light guide, no light will come through, even when pointing the distal end at a light source.

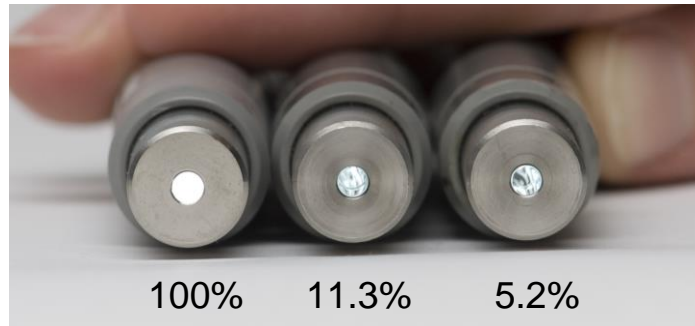

11.2.11 Appearance and % output of light guides with bubbles relative to an LLG without bubbles (100%).

Can a bubbled light guide recover?

11.2.12 Yes, light guides with small bubbles can sometimes recover. Disconnect the light guide from the X-Cite® unit, and leave the light guide undisturbed on a shelf for 1-2 weeks. For this to be effective, it is important to catch the bubble when it is small.

When should light guides be replaced?

11.2.13 It is usually time to replace a light guide when:

- Illumination is low and replacing the lamp does not improve brightness
- Dark or uneven areas become visible in the field of view (a bubble is blocking part of the light)
- A section of the light guide becomes noticeably warmer than the rest of the guide (a bubble is blocking transmission of light, forcing the light guide to absorb the energy)
- It is 2-3 years old OR has been in use for 4000-6000 hours (2-3 lamp changes)

11.3 Lamps

Performance and lifetime

11.3.1 The lamp output spectra and typical output levels over lifetime are shown below.

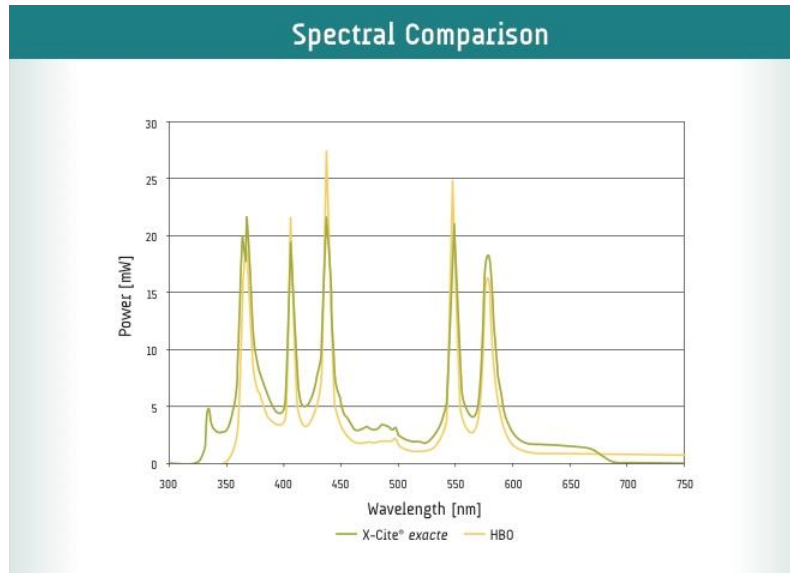

11.3.2 It is normal for the output to decline over the first several hundred hours of use and then stabilize at a level ~70% of the initial output for the remainder of the lamp life. If the lower power regions of the output spectra are being used, it may be desirable to replace lamps more frequently to maximize signal levels.

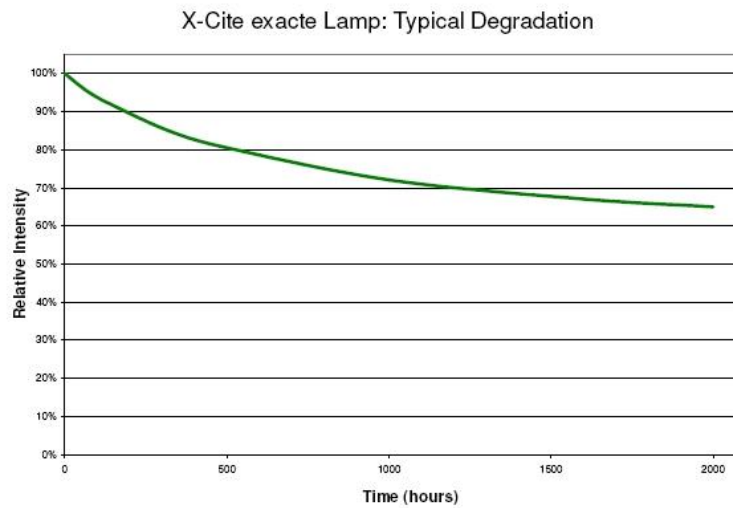

General tips to help maximize lamp lifetime:

1. Each time the lamp is ignited, the stress on the lamp effectively decreases lamp life by 5 hours, therefore it is recommended to avoid shutting down the unit during lunch or short breaks or between users, if being used in a multi-user lab
2. After lamp ignition, avoid turning the lamp off until it has run for a minimum of 20 minutes
3. Avoid attempting to strike a hot lamp (note: the X-Cite®'s Intelli-Lamp will prevent this)
4. Avoid unnecessary movement and jarring of the lamp, especially when it is in operation or hot.
5. When changing a lamp:
 - a. Handle the lamp only by the ceramic areas
 - b. Never touch the glass envelope of the bulb (inner stem), the inner surface, or the outer surface of the reflector. If touched, carefully clean the envelope with alcohol. Skin oils can etch the glass and cause premature bulb failure
 - c. Wear cotton gloves or powder free latex/nitrile gloves when handling any lamp
6. Ensure that air filters are kept clear of dust and debris – even a partially blocked filter can reduce lamp lifetime to approximately 25% of what is normally expected.

11.4 Replacing the Lamp Module

- 11.4.1 The X-Cite® *exacte* is designed to operate only with the X-Cite® *exacte* lamp module supplied by an authorized Excelitas Technologies distributor. When the lamp requires replacing, use only:

Excelitas Technologies Part #	Description
012-66000R	X-Cite® <i>exacte</i> replacement lamp module

Refer to [Section 5.1](#) for lamp module replacement instructions
Refer to [Section 10](#) for messages regarding troubleshooting and lamp module replacement.



Refer to [Section 3.1](#) Glossary of Symbols, for lamp warning information.
Refer to [Section 6.1](#) Powering Up/Powering Down, powering up/down instructions.

11.5 Air Vents & Filters

11.5.1 X-Cite® units have several air vents that are an integral part of the cooling system and overall lamp performance. Proper cooling ensures that lamps operate at optimal temperature and pressure for output power, spectrum, lamp life, light guide life and safety.

Ensuring adequate cooling

11.5.2 Never obstruct the air vents on the X-Cite® unit. Vents are located at the rear and underside of the unit. (Note: Arrows indicate direction/location of air flow. In earlier X-Cite® models vents were located on the side, underneath the lamp access panel.)



- 11.5.3 Always leave clearance for air flow between the X-Cite® and walls or other equipment. Do not remove the rubber feet on the X-Cite® unit or otherwise reduce/block the space between the bottom of the unit and bench top. This may compromise airflow through the unit.



- 11.5.4 Ensure that the air being used to ventilate the X-Cite® unit is approximately “room temperature” (e.g. do not place the X-Cite® unit on top of another heat-producing instrument).
- 11.5.5 If a heated environmental chamber is being used for live cell imaging, make sure that the X-Cite® unit and the light guide are located outside of the chamber.
- 11.5.6 Periodically check the air filter at the air intake vent for debris. Replace or clean as necessary

What happens if filters are not clean?

- 11.5.7 A complete filter blockage or airflow obstruction generally results in an automatic lamp shutoff within 10-15 minutes of the unit being powered on due to lack of adequate cooling.
- 11.5.8 A partially clogged filter may allow enough airflow for continued operation, but not for optimal cooling. In this case, the result is usually dramatically reduced lamp life, e.g. 400 hours instead of 2500+ hours.

11.6 Replacing the Air Filter



11.6.1 The external air filter is located under the front face plate of the X-Cite[®] *exacte*.

11.6.2 Turn off the main POWER switch and remove the AC POWER cord from the unit.

11.6.3 Gently slide and pull out the filter.

11.6.4 Push in the replacement filter so that it sits flat in place

11.7 Replacing the External Fuses



11.7.1 The external (main) fuses are located in the fuse drawer which is located in the AC inlet module on the rear panel.

11.7.2 Turn off the main POWER switch and remove the AC POWER cord from the unit.

11.7.3 Gently pull out the drawer with the aid of a flat-head screwdriver.

11.7.4 Carefully lever one end of each fuse up from its retaining clip with a small flat-head screwdriver and lift it out.



11.7.5 Replace the blown fuse(s) only with the same type and rating (F5A, 250V). The rear compartment must contain two active fuses.

11.7.6 Close the fuse drawer.

11.7.7 Reconnect the AC POWER cord.

12. Technical Specifications

12.1 Electrical

Power Supply:	Power Factor Corrected, Universal Input
Input Voltage:	100 - 240VAC, 50/60Hz
Current:	3.5A max at 120VAC 2.0A max at 240VAC
Input Surge:	50A max. (cold start)
Protection:	Power supply: Short circuit protection Overvoltage protection: 30-50% above nominal output Overload protection: 110-160% of normal rating
Fuse Rating:	Dual fuse system: each fuse rated at F5.0A 250V, 5x20mm type located in the AC receptacle

12.2 Environmental

Operating Conditions

Ambient Temperature:	15°C to 40°C
Altitude:	2000m max.
Atmospheric Pressure:	700 to 1060 hPa
Relative Humidity:	15% to 95% (non-condensing)
Installation Category:	II
Pollution Degree:	2
Enclosure Rating:	IPX0

Transport and Storage Conditions

Temperature:	-40 to +70°C
Relative Humidity:	10% to 100%
Atmospheric Pressure:	500 to 1060 hPa

12.3 Lamp

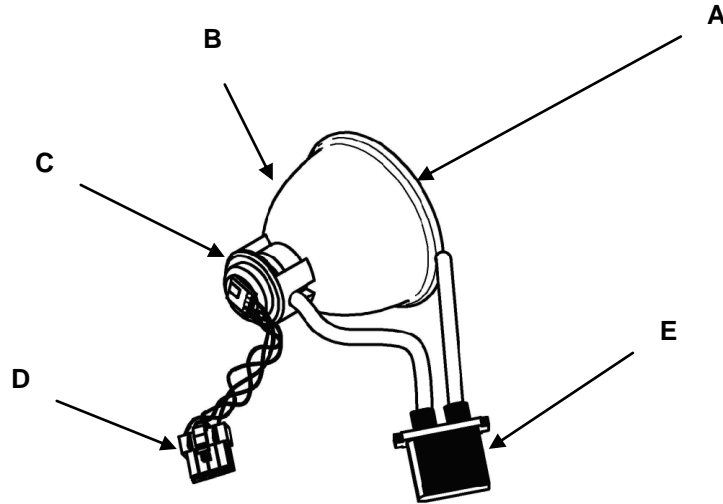

A - Rim of Lamp Reflector . **B** - Reflector. **C** - Back Ceramic Mount
D - Intelli-Lamp Connector. **E** - Power Connector

Lamp Module

Excelitas Technologies 200W Arc Lamp

Lamp Module Life

2000 hours



Warm Up

20 minutes (min), reference sections 3.1 Glossary of Symbols and 6.1 Powering Up/Powering Down.



CAUTION:

Use only Excelitas Technologies lamp part number 012-66000R in the X-Cite® *exacte* unit.

12.4 Light Guide

Light Delivery

Flexible liquid filled light guide 1.5m or 3m in length with a core diameter of 3mm. Custom light guides are also available.

Liquid Light Guide End Fitting

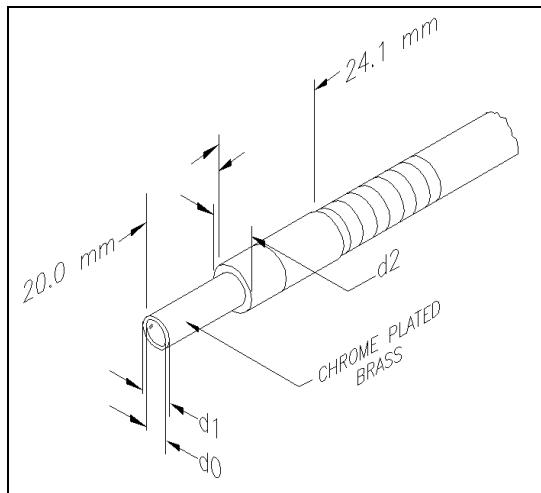

Liquid Light Guide Dimensions in mm

Core	End Fitting	End Fitting Radius	Minimum Bend (mm)
d0	d1	d2	
3	5	9	40

Transport and Storage Conditions

Temperature: -5°C to 35°C

Note: Refer to section 5.3 for tips on maintaining liquid light guides in good working condition.

12.5 General

Height : 8.2" / 20.6cm
 Depth: 13.3" / 33.8cm
 Width: 7.1" / 18.0cm
 Weight: 10.8lbs / 4.9kg

Note: X-Cite® *exacte* unit dimensions only, does not include clearance at front of unit for liquid light guide.

13. Regulatory

13.1 Product Safety and Electromagnetic Compatibility:

The X-Cite® *exacte* has been tested and found to comply with product safety and electromagnetic compatibility requirements. For a complete list of tests and for certification details, please contact your X-Cite® representative or visit <http://www.excelitas.com/Pages/Product/X-Cite-exacte.aspx>.

CE Marking:

Council Directive 2014/35/EU

Low Voltage Directive

Council Directive 2014/30/EU

EMC Directive

Council Directive 2012/19/EU

WEEE Directive

Council Directive 2011/65/EU

RoHS Directive



FCC Class B Digital Device or Peripheral - Information to User

NOTE

This equipment has been tested and found to comply with the limits for a Class B digital device, pursuant to Part 15 of the FCC Rules. These limits are designed to provide reasonable protection against harmful interference when the equipment is operated in a commercial environment. This equipment generates, uses, and can radiate radio frequency energy and, if not installed and used in accordance with the instruction manual, may cause harmful interference to radio communications. Operation of this equipment in a residential area is likely to cause harmful interference in which case the user will be required to correct the interference at his own expense.

WARNING

Changes or modifications not expressly approved by Excelitas Technologies could void the user's authority to operate the equipment.

WEEE Directive (2012/19/EU)



The symbol above indicates that this product should not be disposed of along with municipal waste, that the product should be collected separately, and that a separate collection system exists for all products that contain this symbol within member states of the European Union.

- The equipment that you bought has required the extraction and use of natural resources for its production. It may contain hazardous substances that could impact health and the environment.

- In order to avoid the dissemination of those substances in our environment and to diminish the pressure on the natural resources, we encourage you to use the appropriate take-back systems. Those systems will reuse or recycle most of the materials of your end life equipment in a sound way.
- The crossed-out wheeled bin symbol indicated above invites you to use those systems.
- If you need more information on the collection, reuse and recycling systems, please contact your local or regional waste administration.

13.2 China RoHS



The symbol above indicates that this product is in compliance with China RoHS requirements.

14. Warranty

Excelitas Technologies warrants the original purchaser for a period of one (1) full year, calculated from the date of purchase, that the equipment sold is free from defects in material and workmanship.

In the event of a claim under this guarantee, the equipment is to be sent postage and carriage paid, including a description of the fault, to the Excelitas Technologies Service Center. Returned equipment will not be received without a Return Authorization (RA) Number, issued by the appropriate Service Center.

In the case of damage caused by wear and tear, careless handling, neglect, by the use of force or in the case of interventions and repairs not carried out by an Excelitas Technologies Service Center, the guarantee ceases to be valid. This guarantee may not form the basis for any claims for damages, in particular not for compensation of consequential damages.

The warranty is not transferable. No warranty is extended to perishable items, such as fuses, air filters and light guides.

Any claims for units received with defects in material or workmanship must be reported to an authorized Excelitas Technologies service Center within 30 days from the original date of receipt.

Replacement Bulb Warranty

If the X-Cite[®] *exacte* bulb fails to strike during the warranty period of 2000 hours, the bulb will be replaced under warranty, or a credit will be applied to the purchaser's account. In the event of a claim under this guarantee, the lamp is to be sent postage and carriage paid, including a description of the fault, to the Excelitas Technologies Service Center. Returned equipment will not be received without a Return Authorization (RA) Number, issued by the appropriate Service Center. Lamps must be purchased from an authorized Excelitas Technologies Representative or Distributor to be eligible for the warranty replacement. This warranty is non-transferable.

In the case of damage caused by careless handling, neglect, by the use of force or in the case of interventions and repairs not carried out by an Excelitas Technologies Service Center to the X-Cite[®] *exacte* system, the guarantee ceases to be valid.

Returning equipment to Excelitas Technologies

1. Please make a note of the problem encountered, the steps followed to isolate the problem and the result of any trouble shooting steps taken.
2. Contact the nearest Excelitas Technologies Service Center to obtain a Return Material Authorization (RMA). For your convenience, RMA numbers can also be requested on-line at: <http://www.excelitas.com/Pages/Support/Service-Request-Form.aspx>

3. Follow shipping instructions provided by the service technician. The unit should be returned in its original packaging if possible. Please do not ship the unit with the lamp installed.

15. Contact Information

Excelitas Canada Inc,
 Tel: (905) 821-2600
 Fax: (905) 821-2055
 1-800-668-8752 (USA and Canada)
x-cite@excelitas.com
<http://www.excelitas.com/Pages/Product/X-Cite.aspx/asc.php>

15.1 Replacement Parts and Accessories

Replacement parts and accessories can be purchased directly from Excelitas Technologies. For ordering and pricing information contact the inside sales department at:

(905) 821-2600
 1-800-668-8752 (USA and Canada)
x-cite@excelitas.com
<http://www.excelitas.com/Pages/Contact/Contact-Us.aspx>

Part Number	Description
012-66000R	X-Cite [®] <i>exacte</i> lamp module
805-00038	X-Cite [®] Liquid Light Guide 3mm x 1.5m
805-00040	X-Cite [®] Liquid Light Guide 3mm x 3.0m
622-00012R	Replacement air filter
850-00023R	Hex Key, 3mm (lamp access cover)
010-00245R (Optical Power Measurement System)	X-Cite [®] XR2100 Optical Power Meter (010-00242R) X-Cite [®] XP750 Objective Plane Power Sensor (010-00241R)
035-00287	X-Cite [®] <i>exacte</i> Quick Start English