



USER MANUAL Evolve® 512



User Manual for Evolve 512



© Copyright 2009
Photometrics
3440 East Britannia Drive
Tucson, Arizona 85706
Tel: 800.874.9789/520.889.9933
Fax: 520.295.0299

All rights reserved. No part of this publication may be reproduced by any means without the written permission of Photometrics, a division of Roper Scientific, Inc.

Printed in the United States of America.

Acrobat and Reader are registered trademarks of Adobe Systems Incorporated in the United States and/or other countries. Pentium is a registered trademark of Intel Corporation.

Photometrics, PVCAM, and Evolve are registered trademarks of Roper Scientific, Inc.

Mac, Macintosh and FireWire are trademarks of Apple Computer, Inc., registered in the U.S. and other countries.

Windows and Windows XP are registered trademarks of Microsoft Corporation in the United States and/or other countries.

Other brand and product names are the trademarks or registered trademarks of their respective owners and manufacturers.

The information in this publication is believed to be accurate as of the publication release date. However, Photometrics does not assume any responsibility for any consequences including any damages resulting from the use thereof. The information contained herein is subject to change without notice. Revision of this publication may be issued to incorporate such change.

Customer Service

If you have any questions about your camera system, please contact Photometrics Customer Service. When you call, please have your Photometrics part number or equipment serial numbers available.

USA

Photometrics
3440 East Britannia Drive
Tucson, Arizona 85706
tel: 800.874.9789 or
520.889.9933
fax: 520.295.0299
email: cservice@photomet.com

GERMANY

Roper Scientific, GmbH
Rosenheimer Landstr. 87
D-85521 Ottobrunn, Germany
tel: 49.89.660.779.3
fax: 49.89.660.779.50
email: support@roperscientific.de

BENELUX

Roper Scientific, BV
Ir. D.S. Tuijnmanweg 10
4131 PN VIANEN, Netherlands
tel: 31.347.324989
fax: 31.347.324979
email: mailto@roperscientific.com

JAPAN

Nipon Roper, K.K.
D-10E 1-3 Nakase,
Mihama-ku, Chiba-shi
Japan 261-8501
tel: 81.43.274.8022
fax: 81.43.274.8023
email: sales@roper.co.jp

FRANCE

Roper Scientific, SARL
Z.I. Petite Montagne Sud
4, rue de l'Oisans - C.E. 1702
91017 Evry Cedex, France
tel: 33.160.86.03.65
fax: 33.160.86.07.09
email: princeton.instruments@wanadoo.fr

UK

Photometrics UK Ltd.
Beech House
27 Little Marlow Road
Marlow
Buckinghamshire
SL7 1HA
Tel: 44 1628 890858
Fax: 44 1628 898381
email: UKsupport@photomet.co.uk

LIMITED WARRANTY

Photometrics, a division of Roper Scientific, Inc., (“Photometrics,” us,” “we,” “our”) makes the following limited warranties. These limited warranties extend to the original purchaser (“You”, “you”) only and no other purchaser or transferee. We have complete control over all warranties and may alter or terminate any or all warranties at any time we deem necessary.

Basic Limited One (1) Year Warranty

Photometrics warrants this product against substantial defects in materials and / or workmanship for a period of up to one (1) year after shipment. During this period, Photometrics will repair the product or, at its sole option, repair or replace any defective part without charge to you. You must deliver the entire product to the Photometrics factory or, at our option, to a factory-authorized service center. You are responsible for the shipping costs to return the product. International customers should contact their local Photometrics authorized representative/distributor for repair information and assistance, or visit our technical support page at www.photometrics.com.

Limited One (1) Year Warranty on Refurbished or Discontinued Products

Photometrics warrants, with the exception of the CCD imaging device (which carries NO WARRANTIES EXPRESS OR IMPLIED), this product against defects in materials or workmanship for a period of up to one (1) year after shipment. During this period, Photometrics will repair or replace, at its sole option, any defective parts, without charge to you. You must deliver the entire product to the Photometrics factory or, at our option, a factory-authorized service center. You are responsible for the shipping costs to return the product to Photometrics. International customers should contact their local Photometrics representative/distributor for repair information and assistance or visit our technical support page at www.photometrics.com.

Normal Wear Item Disclaimer

Photometrics does not warrant certain items against defect due to normal wear and tear. These items include internal and external shutters, cables, and connectors. *These items carry no warranty, expressed or implied.*

Sealed Chamber Integrity Limited 24 Month Warranty

Photometrics warrants the sealed chamber integrity of all our products for a period of twenty-four (24) months after shipment. If, at anytime within twenty-four (24) months from the date of delivery, the detector should experience a sealed chamber failure, all parts and labor needed to restore the chamber seal will be covered by us. *Open chamber products carry NO WARRANTY TO THE CCD IMAGING DEVICE, EXPRESSED OR IMPLIED.* Responsibility for shipping charges is as described above under our Basic Limited One (1) Year Warranty.

Vacuum Integrity Limited 24 Month Warranty

Photometrics warrants the vacuum integrity of all our products for a period of up to twenty-four (24) months from the date of shipment. We warrant that the detector head will maintain the factory-set operating temperature without the requirement for customer pumping. Should the detector experience a Vacuum Integrity failure at anytime within twenty-four (24) months from the date of delivery all parts and labor needed to restore the vacuum integrity will be covered by us. Responsibility for shipping charges is as described above under our Basic Limited One (1) Year Warranty.

Software Limited Warranty

Photometrics warrants all of our manufactured software discs to be free from substantial defects in materials and / or workmanship under normal use for a period of one (1) year from shipment. Photometrics does not warrant that the function of the software will meet your requirements or that operation will be uninterrupted or error free. You assume responsibility for selecting the software to achieve your intended results and for the use and results obtained from the software. In addition, during the one (1) year limited warranty. The original purchaser is entitled to receive free version upgrades. Version upgrades supplied free of charge will be in the form of a download from the Internet. Those customers who do not have access to the Internet may obtain the version upgrades on a CD-ROM from our factory for an incidental shipping and handling charge. *See Item 12 in the following section of this warranty ("Your Responsibility") for more information.*





Owner's Manual and Troubleshooting

You should read the owner’s manual thoroughly before operating this product. In the unlikely event that you should encounter difficulty operating this product, the owner’s manual should be consulted before contacting the Photometrics technical support staff or authorized service representative for assistance. If you have consulted the owner's manual and the problem still persists, please contact the Photometrics technical support staff or our authorized service representative. *See Item 12 in the following section of this warranty ("Your Responsibility") for more information.*

Your Responsibility

The above Limited Warranties are subject to the following terms and conditions:

1. You must retain your bill of sale (invoice) and present it upon request for service and repairs or provide other proof of purchase satisfactory to Photometrics.
2. You must notify the Photometrics factory service center within (30) days after you have taken delivery of a product or part that you believe to be defective. With the exception of customers who claim a “technical issue” with the operation of the product or part, all invoices must be paid in full in accordance with the terms of sale. Failure to pay invoices when due may result in the interruption and/or cancellation of your one (1) year limited warranty and/or any other warranty, expressed or implied.
3. All warranty service must be made by the Photometrics factory or, at our option, an authorized service center.
4. Before products or parts can be returned for service you must contact the Photometrics factory and receive a return authorization number (RMA). Products or parts returned for service without a return authorization evidenced by an RMA will be sent back freight collect.
5. These warranties are effective only if purchased from the Photometrics factory or one of our authorized manufacturer's representatives or distributors.
6. Unless specified in the original purchase agreement, Photometrics is not responsible for installation, setup, or disassembly at the customer's location.
7. Warranties extend only to defects in materials or workmanship as limited above and do not extend to any product or part which has:
 - been lost or discarded by you;
 - been damaged as a result of misuse, improper installation, faulty or inadequate maintenance or failure to follow instructions furnished by us;
 - had serial numbers removed, altered, defaced, or rendered illegible;
 - been subjected to improper or unauthorized repair; or
 - been damaged due to fire, flood, radiation, or other “acts of God” or other contingencies beyond the control of Photometrics.
8. After the warranty period has expired, you may contact the Photometrics factory or a Photometrics-authorized representative for repair information and/or extended warranty plans.
9. Physically damaged units or units that have been modified are not acceptable for repair in or out of warranty and will be returned as received.
10. All warranties implied by state law or non-U.S. laws, including the implied warranties of merchantability and fitness for a particular purpose, are expressly limited to the duration of the limited warranties set forth above. With the exception of any warranties implied by state law or non-U.S. laws, as hereby limited, the forgoing warranty is exclusive and in lieu of all other warranties, guarantees, agreements, and similar obligations of manufacturer or seller with respect to the repair or replacement of any parts. In no event shall Photometrics' liability exceed the cost of the repair or replacement of the defective product or part.
11. This limited warranty gives you specific legal rights and you may also have other rights that may vary from state to state and from country to country. Some states and countries do not allow limitations on how long an implied warranty lasts, when an action may be brought, or the exclusion or limitation of incidental or consequential damages, so the above provisions may not apply to you.
12. When contacting us for technical support or service assistance, please refer to the Photometrics factory of purchase, contact your authorized Photometrics representative or reseller, or visit our technical support page at www.photometrics.com.

Auftraggeber:	Photometrics 3440 East Britannia Drive Tucson, AZ 85706 USA	Contact: Joe Lamb Phone: (520) 889-9933 Fax: (520) 573-1944 Email: jlamb@photomet.com	
Bezeichnung: <i>Identification:</i>	EMCCD Camera	Serien-Nr.: <i>Serial No.</i>	Camera: A09D103002 and A09D103000; Power Supply: A09D104004
Gegenstand der Prüfung: <i>Test item:</i>	Evolve 512	Prüfdatum: <i>Date tested:</i>	Apr. 27, 2009 – May 14, 2009
Prüfört: <i>Testing location:</i>	TÜV Rheinland of North America, Inc. 2305 Mission Collage Blvd., Suite 105 Santa Clara, CA 95054 USA		
Prüfgrundlage: <i>Test specification:</i>	2004/108/EC EN 61326: 2006 FCC Part 15: 2008, Subpart B.		
Prüfergebnis: <i>Test Result</i>	Der vorstehend beschriebene Prüfgegenstand wurde geprüft und entspricht oben genannter Prüfgrundlage. The above product was found to be Compliant to the above test standard(s)		
geprüft / tested by: Adam La Course		kontrolliert / reviewed by: Kent Chesley	
Datum <i>Date</i>	 Name <i>Name</i>	Unterschrift <i>Signature</i>	Datum <i>Date</i>
			 Name <i>Name</i>
			Unterschrift <i>Signature</i>
Sonstiges: <i>Other Aspects:</i>	None		
Abkürzungen:	OK, Pass, Compliant, Complies = entspricht Prüfgrundlage Fail, Not Compliant, Does not Comply = entspricht nicht Prüfgrundlage N/A = nicht anwendbar	Abbreviations:	OK, Pass, Compliant, Complies = passed Fail, Not Compliant, Does Not Comply = failed N/A = not applicable
			
US5251	NVLAP CODE 500011		

The test results contained in this report refer exclusively to the product(s) presented for testing. No liability may be assumed for models or products not referred to herein. This test report may not be published or duplicated in part without permission of the testing body. This test report by itself does not constitute authorization for the use of any TÜV Rheinland test mark. The report must not be used by the client to claim product certification, approval, or endorsement by NVLAP, NIST, or any agency of the Federal Government.

TÜV Rheinland Inc., North American Headquarters, 12 Commerce Road, Newtown, CT 06470 - Tel (203)426-0888 - Fax (203)426-4009

QF0904040

Rev 1.0

Table of Contents

Chapter 1 Overview

Introduction	1
Technology Introduction	1
System Components	2
About This Manual	3
Precautions.....	3
Environmental Requirements	4
Storage Requirements.....	4
Microscopes, Lenses, and Tripods.....	4
Repairs	4
Cleaning	4

Chapter 2 System Installation

Introduction	5
Software Compatibility Requirements.....	5
Host Computer Requirements	6
Multiple Cameras.....	6
Software Installation.....	6
Installing the FireWire Interface Card.....	7
Connecting Your Evolve 512 Camera	7
To connect your Evolve 512 camera	7

Chapter 3 Operating Features

Introduction	9
On-Chip Multiplication Gain.....	9
Offset (bias)	9
Exposure- Readout Modes.....	9
Non-Overlap Mode.....	10
Example: Non-Overlap Mode.....	11
Overlap Mode (Simultaneous Exposure-Readout)	12
Triggered Operation.....	14
Trigger-first Mode	14
Strobe Mode	15
Bulb Mode	16
Conversion Gain	16
Readout Speed (Typical)	17
Binning	17
Evolve 512 Features	18
Vari-Bit.....	18
Quant-View	19
Rapid-Cal.....	20
Background Event Reduction Technology	21
Black-Lock / Top-Lock	22
Dual-Readout Port Operation	23
Conversion Gain	25
Readout Speed (typical).....	25
Binning	25
Evolve 512 Application Examples.....	26

Application Settings Summary	26
Chapter 4 Troubleshooting	
System Does Not Boot Normally	27
New Hardware Found Dialog Box Does Not Appear (Windows 2000/XP).....	27
Images Not Displayed.....	28
Camera Running Too Warm.....	28
PVCAM Error Message Appears.....	28
Lengthy Pauses During Imaging.....	28
Evolve 512 Will Not Image When Attached to Certain Dual-processor or Hyperthreading-capable PCs.....	28
Chapter 5 Basic Specifications	
Evolve 512 Front/Side Views.....	29
Camera Weight	30
CCD Specifications	30
Connectors	30
Power Connector Pinout:.....	31
Power Supply Specifications	33
Appendix	
Liquid Cooled Evolve Setup Instructions.....	34
Index.....	35
Figures	
Figure 1. Comparison of Traditional CCD and Evolve CCD Array Structures	2
Figure 2. FireWire interface Card	2
Figure 3. DATA Cable.....	7
Figure 4. Evolve 512 Side Panel	8
Figure 5. Non-overlap Mode Operational Sequence.....	10
Figure 6. Required Settings for Non-Overlap Mode Operation.....	11
Figure 7. Timing Diagram for Non-Overlap Mode.....	11
Figure 8. Required Settings for Overlap Mode Operation	12
Figure 9. Timing Diagram for Overlap Mode when Exposure Time < Readout Time	13
Figure 10. Timing Diagram for Overlap Mode when Exposure Time > Readout Time	14
Figure 11. Trigger-First Mode Timing Diagram: Overlap Mode.....	14
Figure 12. Trigger-First Mode Timing Diagram: Non-Overlap Mode	15
Figure 13. Strobe Mode Timing Diagram	15
Figure 14. Bulb Mode Timing Diagram	16
Figure 15. Benefit of Varibit.....	18
Figure 16. DAC Setting vs. Charge Multiplication Gain for Evolve 512	20
Figure 17. RapidCal Status.....	21
Figure 18. BERT Off vs BERT On.....	22
Figure 19. Evolve 512 CCD Array Structure	23
Figure 20. Software Selection of Readout Port.....	24
Figure 21. Evolve 512 Front View	29
Figure 22. Evolve 512 Side View.....	29
Figure 23. Evolve 512 Side Panel.....	30
Figure 24. Power Connector Pinout.....	31
Figure 25. Input/Output Connector.....	32
Figure 26. Power Supply Front	33
Figure 27. Liquid Cooled Evolve Setup Diagram.....	34

Tables

Table 1. Evolve 512 Readout Speeds and Typical Conversion Gains	25
Table 2. Application Type and Evolve 512 Setup Parameters	26
Table 3. CCD Specifications	30
Table 4. Input/Output Definitions	32

THIS PAGE INTENTIONALLY LEFT BLANK

Chapter 1

Overview

Introduction

The Photometrics® Evolve™ camera employs an advanced CCD technology called "impact ionization" to achieve charge multiplication gain above the read noise. As a result, the cameras offer unparalleled sensitivity even at high frame rates.

Evolve cameras are most suited for high speed and/or low-light level imaging applications such as single molecule fluorescence, ion imaging, and adaptive optics. With the traditional readout amplifier, the Evolve can also be used for standard fluorescence and imaging applications requiring higher dynamic range.

Currently the Evolve line consists of the following camera model:

- Evolve 512
 - Uses a 512x512 Back-illuminated CCD with 16x16 μm pixels.
 - Has two readout amplifiers - one that offers charge multiplication gain and another for traditional readout.

Technology Introduction

The principal difference between a charge-multiplying CCD and a traditional CCD is the presence of an extended serial register in the new device (see Figure 1). Electrons are accelerated from pixel to pixel in the extended portion of the serial register (also referred to as a multiplication register) by applying higher-than-typical CCD clock voltages. This causes secondary electrons to be generated in the silicon by impact ionization. The degree of multiplication gain is controlled by increasing or decreasing clock voltages for this register (gain is exponentially proportional to the voltage). Although the probability of generating secondary electrons is fairly low (typically 0.01 per stage), over the large number of stages of a typical multiplication register, the total gain can be quite high.

This technology combines the ease of use and robustness of a traditional CCD with the gain capabilities of an intensified CCD in a single device. The combination of this technology with frame-transfer readout makes the Evolve cameras excellent choices for experiments where fast framing and low light sensitivity are required.

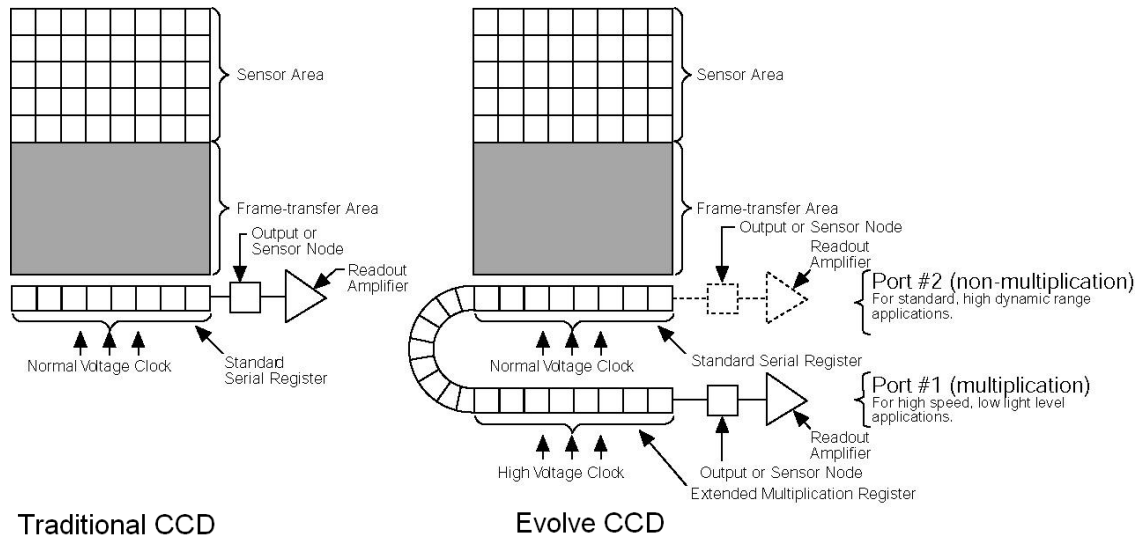

Figure 1. Comparison of Traditional CCD and Evolve CCD Array Structures

The Evolve 512 also offers a non-multiplication readout similar to the one available in traditional CCD cameras. This makes these more versatile cameras that can be used for standard imaging applications requiring higher dynamic range.

System Components

The Evolve 512 package includes PVCAM[®] drivers and Micro-Manager[™] imaging software along with a Firewire cable, a Firewire Interface PCI card, and a test lens.



Figure 2. FireWire interface Card

About This Manual

The Evolve 512 User Manual is divided into five chapters. It is suggested that you read the entire manual before operating the camera in order to ensure proper use. The chapter contents are briefly described below.

Note: The information in these chapters applies only to the Evolve 512 and is currently not applicable to any other Photometric camera.

- Overview – This is a basic overview of the Evolve 512 that includes precautions and general maintenance/equipment information.
- System Installation – Instructions for connecting your Evolve 512 camera to your computer via the Evolve FireWire interface card.
- Operating Features – Discusses Evolve 512 features such as on-chip multiplication gain, readout, and trigger modes. Provides additional information on dual-readout mode feature available.
- Troubleshooting – Provides answers to camera system problems.
- Basic Specifications – Provides specifications for Evolve 512 system components.

Precautions

The CCD and other system electronics are extremely sensitive to electrostatic discharge (ESD). To avoid permanently damaging the system, please observe the following precautions:

- If you are using high-voltage equipment (such as an arc lamp) with your camera system, be sure to turn the camera power on last and power the camera off first.
- Never connect or disconnect any cable while the system is powered on.
- Although you should switch off the camera's power before disconnecting any camera system cable, you do not need to power off your computer to detach the cables.
- Use caution when triggering high-current switching devices (such as an arc lamp) near your system. The CCD can be permanently damaged by transient voltage spikes. If electrically noisy devices are present, an isolated, conditioned power line or dedicated isolation transformer is highly recommended.
- Always leave one inch of space around the camera's external cooling fins for airflow.
- Never open the camera. There are no user-serviceable parts inside the Evolve 512 camera. Opening the camera voids the warranty.
- Use only the FireWire interface card, cables, and power supply designated for this camera system. Using non-Evolve cables, FireWire interface cards, or power supplies may result in permanent damage to your system.
- Do not use a C-mount lens with optics that extend behind the lens flange.

Environmental Requirements

The Evolve 512 camera system should be operated in a clean, dry environment. The camera system's ambient operating temperature is 0°C to 30°C with 80% relative humidity, non-condensing.

Storage Requirements

Store the Evolve 512 camera system in its original containers. To protect the system from excessive heat, cold, and moisture, store at an ambient temperature between -20°C and 60°C with a relative humidity of 0% to 90%, noncondensing.

Microscopes, Lenses, and Tripods

The camera has a standard threaded video mount and can be mounted to any microscope that accepts a standard C-mount adapter. The camera also allows you to install any lens that is compatible with a standard threaded video mount as long as its optics do not extend behind the flange of the lens. The Evolve 512 camera can be mounted to a tripod using the tripod mounting attachment located on the sides of the camera.

The Evolve 512 C-mount adapter is designed so it can be screwed in or out to change the focal depth. Once the focal depth has been changed, the adapter is secured by two setscrews. See Adjusting the C Mount Adapter (Chapter 2) for more information.

Repairs

The Evolve 512 camera system contains no user-serviceable parts. Repairs must be done by Photometrics. Should your camera system need repair, contact Photometrics Customer Service. Please save the original packing materials so you can safely ship the camera system to another location or return it for repairs if necessary.

Note: Do not open the camera. Opening the Evolve 512 camera voids the warranty.

Cleaning

Clean exterior surfaces of the camera with a dry, lint-free cloth. To remove stains, contact Photometrics Customer Service. To clean the camera's imaging window, use only a filtered compressed-air source. Hand-held cans are not recommended, as they may spray propellant onto the window. Do not touch the window.

Chapter 2

System Installation

Carefully review the Precautions section in the previous chapter before performing any of the procedures outlined here. Again, use only an Evolve data cable and an Evolve FireWire interface card with your Evolve 512 camera. Using a different cable or interface card may result in permanent damage to your system.

Introduction

Your Evolve 512 camera system has the following hardware components:

- Camera head
- FireWire interface card
- Data cable
- Power supply with power cord
- Red test lens
- CD-ROM
- Quick installation Guide

Evolve 512 system components are linked by the data cable and controlled by your host computer system. All of these hardware components should be included with your shipment. Refer to the information and figures in the System Components section (Chapter 1).

Keep all the original packing materials so you can safely ship the Evolve 512 system to another location or return it for service if necessary.

If you have any difficulty with any step of the instructions, call Photometrics Customer Service.

Software Compatibility Requirements

The Evolve 512 package includes the PVCAM drivers and the Micro-Manager software program designed for use with this camera.

All other imaging software must also be PVCAM-compatible. For full access to Evolve 512 hardware functions, the current version of PVCAM must be used.

Host Computer Requirements

The host computer (PC) for your Evolve 512 camera must have the following:

- Windows® XP (SP2) operating system
- 1 GHz Pentium® 4 (or greater)
- 256 MB RAM (or greater)
- CD-ROM drive
- At least one unused traditional PCI or PCI-X card slot
- 16-bit color display (or greater)

Note: The above requirements are the minimum for operating an Evolve camera. A faster computer with larger memory (RAM) will greatly enhance the software performance during live mode operations.

If you are a Mac® user, the host computer for your Evolve 512 camera must have the following:

- Macintosh® OS X operating system (Power PC based)
- G4/G5 computer
- 256 MB RAM (or greater)
- CD-ROM drive
- At least one unused traditional PCI or PCI-X card slot
- Video adapter that supports 24-bit color (millions of colors)

Multiple Cameras

PVCAM supports multiple open cameras. In order to use this function, it must also be supported by your imaging software.

If your imaging software supports multiple cameras, there must be a separate interface card for each camera.

Software Installation

An Installation Guide appropriate to your system is included as an insert with the camera system. This guide provides step-by-step instructions for installing the camera interface software and the application software for Windows-based computers. Additional instructions are included for installing a FireWire interface card in your computer and capturing images.

The Photometrics CD-ROM contains the following files.

- MacOS directory – contains required files for installing on a Macintosh computer.
- Manuals directory – contains user manuals in PDF format.
- WinOS directory – contains the files for installing on a Windows PC.
- Linux directory – (not applicable to Evolve 512).

Installing the FireWire Interface Card

You will be using an Evolve FireWire interface card to allow the camera to communicate with your computer.

Before installing the interface card, refer to the 'Release Notes' files on the CD-ROM and to the Software Installation insert. The insert instructions will step you through the FireWire interface card installation.

After installing the interface card, continue to *Connecting Your Evolve 512 Camera*.

Connecting Your Evolve 512 Camera

The following connectors are located on the back of the Evolve 512 camera:

- DATA connector: Type 1, 6-pin IEEE-1394a (FireWire) connector for data transfer
- POWER connector: 25-pin, Dsub connector for camera power (see POWER Connector Pinout section in Chapter 5 for details)
- Power switch: Turns the camera on and off.

The following connector is located on the power supply of the Evolve 512 camera:

- I/O connector: Hirose HR10A-10R-10S, 10-pin connector for input/output control signals (see I/O Connector Pinout later in this manual)

To connect your Evolve 512 camera

1. Connect the straight end of the DATA cable to the Evolve FireWire interface card that you have installed in the host computer. The DATA cable (shown below) connects your Evolve 512 camera to the Evolve FireWire interface card. This interface cable is identifiable by its 6-pin connectors. It is designed to serve as a conduit for data.



Figure 3. DATA Cable

2. Connect the right-angled end of the DATA cable to the FireWire port (indicated with a red arrow in next graphic) located on the side of the camera.

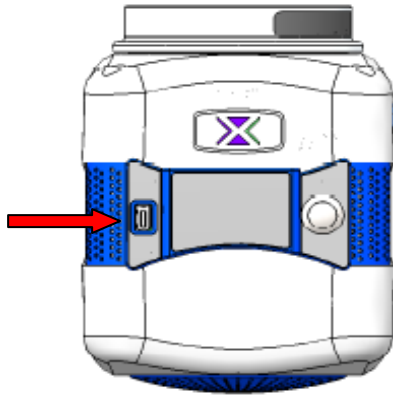

Figure 4. Evolve 512 Side Panel

3. Verify that the power switch on the side of the camera is in the off position.
4. Connect the power supply to the Power connector on the side of the camera.
5. Plug the power cord into the power supply and then into a suitable wall outlet.
6. Switch on the camera (power switch on the side of camera).

Chapter 3

Operating Features

Introduction

The features described in this section are identical in all Evolve 512 cameras unless otherwise stated.

On-Chip Multiplication Gain

As explained previously, the Evolve 512 uses a unique CCD capable of multiplying the charge (electrons) generated in the pixels. When the multiplication is sufficiently high, it is possible to see extremely low-light events. The amount of multiplication is controlled by the voltage applied to multiplication register clocks. These are certified by a quantitative multiplication gain slider which has 0-1000 steps. The calibration feature of the camera maps the gain slider to a voltage which will provide the electron multiplication level selected.

Offset (bias)

CCD cameras are typically designed to produce a certain level of offset (also known as bias) when no light is present and the exposure time is set to zero (0). Typically, the user subtracts an offset (bias) from the sample image for quantitative measurement. Since the offset can change based on several factors such as multiplication gain, speed, etc., it is recommended that a fresh offset (bias) image be taken with the same settings as the sample image and then be subtracted from the sample image.

The Evolve 512 has an automatically adjusting offset switch. When a speed/gain setting is altered, the bias valve is kept as close to a pre-selected offset as possible. This enhances the quantitative stability of the camera.

Exposure- Readout Modes

The Evolve 512 camera uses a frame transfer CCD and supports Non-Overlap and Overlap exposure and readout modes. These modes are further described in the sections that follow.

Note: A frame transfer CCD has both a light-sensitive area (sensor area) and a storage area (frame transfer area). Since the image can be quickly transferred from the sensor area to the frame transfer area, there is no need for a mechanical shutter.

Non-Overlap Mode

Non-Overlap mode allows you to expose the array for the exposure time specified in the software and is similar in performance to a normal, full-frame device. The operational sequence for this mode is:

1. Clearing the CCD,
2. Exposing for the specified exposure time,
3. Shifting the image from the sensor area to the frame-transfer area, and
4. Reading out the CCD.

Steps 1-4 are repeated for each frame in a sequence. Steps 1 and 3, clearing the CCD and shifting the image, are usually very short and typically have minimum impact on the frame rate.

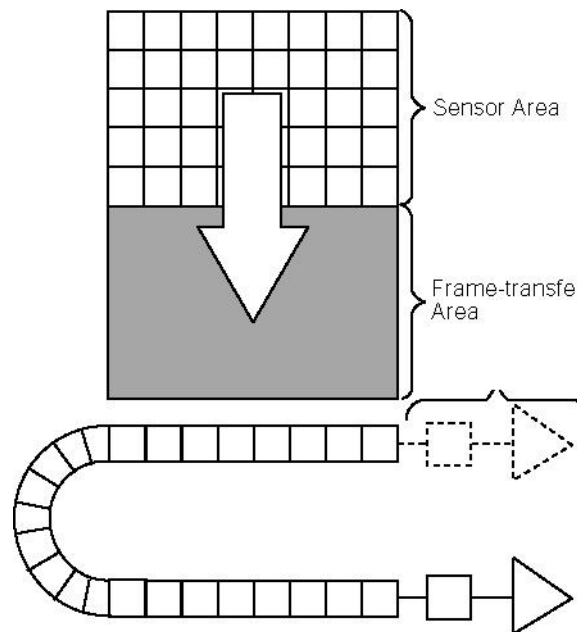

Figure 5. Non-overlap Mode Operational Sequence

In PVCAM compatible software, this sequence is programmed by simply setting:

- clocking mode to “Frame transfer” and
- clearing mode to “Pre-exposure” with clear count of “1” (or more).

Figure. 6 shows these settings on a software dialogue box.

Note: Since the software you are using may show the settings differently, you should refer to the software documentation for accurate information.

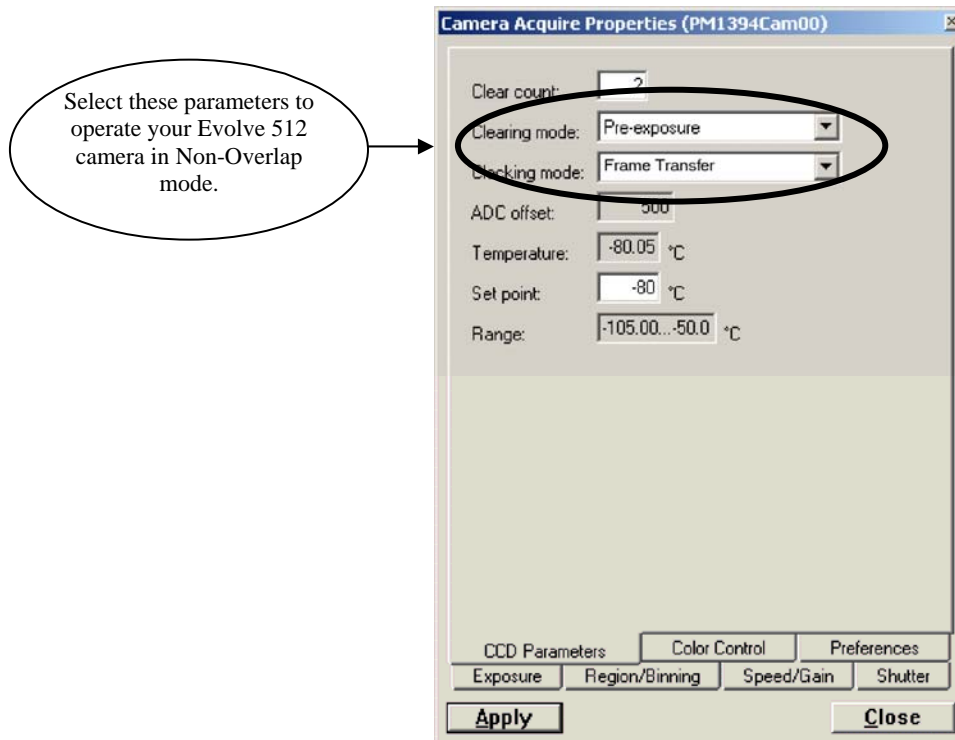

Figure 6. Required Settings for Non-Overlap Mode Operation

**Example:
Non-Overlap
Mode**

Operation in Non-Overlap mode is illustrated in the timing diagram below. In this example, the exposure time is 10 ms and the readout time is 29.5 ms. The total time to take 3 frames is 118.5 ms ($3 \times 10 \text{ ms} + 3 \times 29.5 \text{ ms}$), equivalent to a frame rate of 25.3 fps ($3 \text{ frames} \div 0.1185 \text{ seconds}$).

Note: The exposure and readout times listed are for illustration purpose only. Actual values may vary. Refer to the product data sheet for the actual readout times.

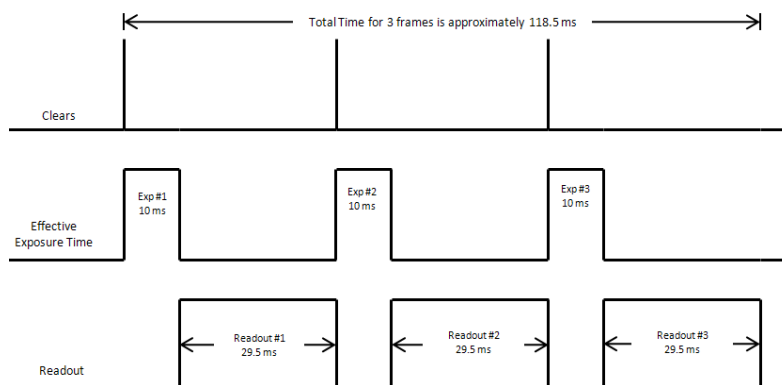

Figure 7. Timing Diagram for Non-Overlap Mode

Referring to figure 7, it can be seen that exposure and readout are carried out in non-overlapped fashion. As a result, each frame in the sequence is precisely exposed for the time specified (i.e. 10 ms).

Overlap Mode (Simultaneous Exposure-Readout)

Overlap mode is extremely useful in applications requiring continuous imaging (100% duty cycle). Once a frame is exposed and transferred into the frame transfer area, the next exposure immediately starts and continues until the previous frame is read out or until the exposure time is finished, whichever is longer (so the minimum effective exposure time in this mode is the readout time). This mode of operation allows you to continuously image a specimen to obtain better kinetic information about a process. Figure 8 shows the required Evolve 512 settings for overlap mode. Note that the clearing mode is set to "Pre-sequence" (as opposed to "Pre-exposure" in Non-Overlap mode).

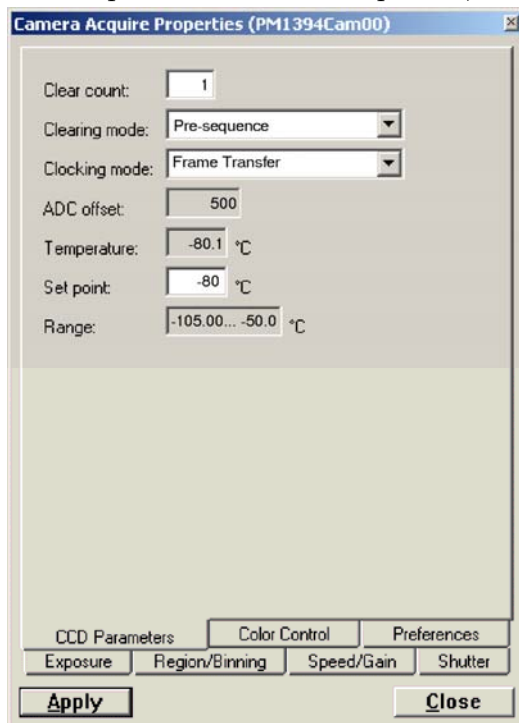

Figure 8. Required Settings for Overlap Mode Operation

Note: In Overlap mode, the minimum effective exposure time is the readout time.

The simultaneous exposure-readout mechanism is illustrated with two examples.

Example 1: Overlap Mode when Exposure Time < Readout Time

Consider a situation where full frame readout is 29.5 ms, the exposure time is 10 ms, and three frames are taken in overlap mode. The first frame is exposed precisely for the length of time entered into the software (10 ms) and all subsequent frames are exposed for the readout time. The total time to acquire 3 frames is then 98.5 ms ($3 \times 29.5 \text{ ms} + 10 \text{ ms}$), equivalent to a frame rate of 30.45 fps ($3 \text{ frames} \div 0.0985 \text{ seconds}$).

Note: Because the first frame is exposed for 10 ms and the others for 29.5 ms, the first frame may look less bright compared to all other frames.

In Overlap mode when exposure time < readout time, the total time (T_N) taken to capture N frames is given by:

$$T_N = (t_R \times N) + t_{exp}$$

Where

T_N = Total time taken to capture a sequence of N frames

t_R = readout time for one frame

N = total number of frames in a sequence

t_{exp} = exposure time

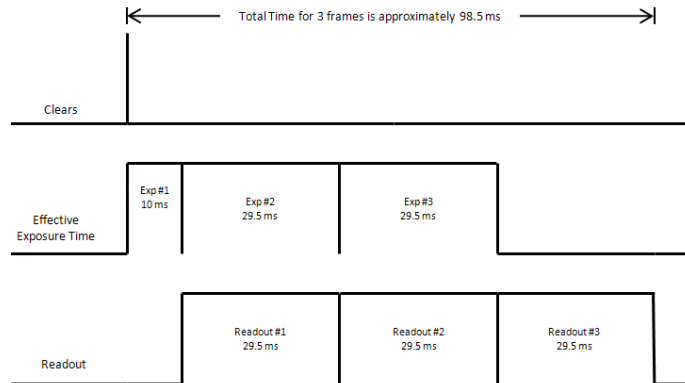

Figure 9. Timing Diagram for Overlap Mode when Exposure Time < Readout Time

Example 2: Overlap Mode when Exposure Time > Readout Time

If the exposure time is set to 50 ms with the readout time remaining at 30 ms, the time taken to acquire 3 frames will be 179.5 ms ($3 \times 50 \text{ ms} + 29.5 \text{ ms}$), which is equivalent to a frame rate of 16.7 fps.

In Overlap mode when exposure time > readout time, the total time (T_N) taken to capture N frames is expressed as:

$$T_N = (t_{exp} \times N) + t_R$$

Where

T_N = Total time taken to capture a sequence of N frames

t_{exp} = exposure time

N = total number of frames in a sequence

t_R = readout time for one frame

From the timing diagram, you can see that because the exposure time is greater than the readout time, all frames are precisely exposed for the duration entered into the software and have similar intensities.

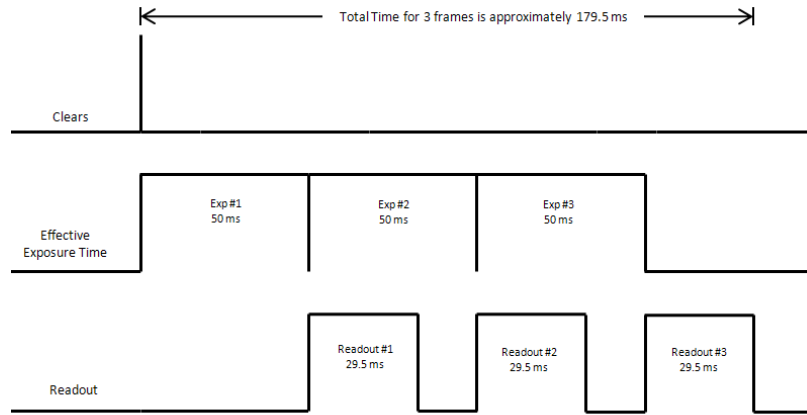

Figure 10. Timing Diagram for Overlap Mode when Exposure Time > Readout Time

Triggered Operation

The Evolve 512 camera offers several methods of integration with external trigger sources, such as delay generators or laser pre-triggers. Each camera has a 10-pin, Hirose HR10A I/O connector (pinout functions are described in Chapter 5) on the power supply for trigger input/output and various TTL input and output operations. A special cable is available from Photometrics to access primary signals such as "Trigger input," "Expose out," "Frame readout," and "Shutter out." In the default mode, the camera triggers on the rising edge of a TTL signal. Evolve 512 cameras support the trigger modes described in the next sections.

Trigger-first Mode

In this mode, the camera requires only one trigger to acquire a sequence of frames. The camera can operate in overlap or non-overlap mode depending on the settings explained in the previous section. Once the initial trigger is received, the camera ignores any further triggers until the entire exposure/readout sequence is completed (see Figures 11 and 12, which show a three-frame sequence).

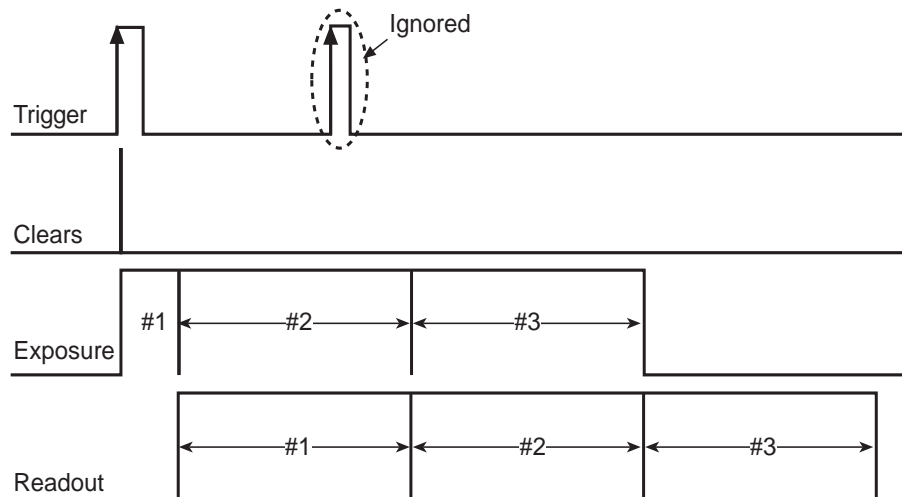

Figure 11. Trigger-First Mode Timing Diagram: Overlap Mode

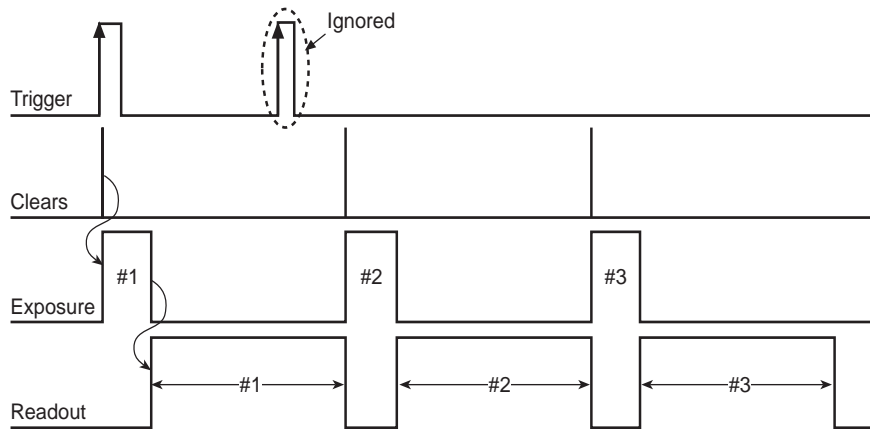



Figure 12. Trigger-First Mode Timing Diagram: Non-Overlap Mode

Strobe Mode

In Strobe mode, each frame in a sequence requires a trigger. Each frame is exposed for the length of time entered into the software and is then read out. If a trigger arrives during the exposure-readout of the previous frame, it is ignored (see Figure 13). For a sequence of one frame, strobe mode and trigger-first mode are the same. The Trigger Ready signal goes high when Read Out is completed. It goes low when the Trigger signal is accepted and exposure is started. The shaded areas  denote the idle time between exposures. Strobe mode only operates in Non-Overlap mode.

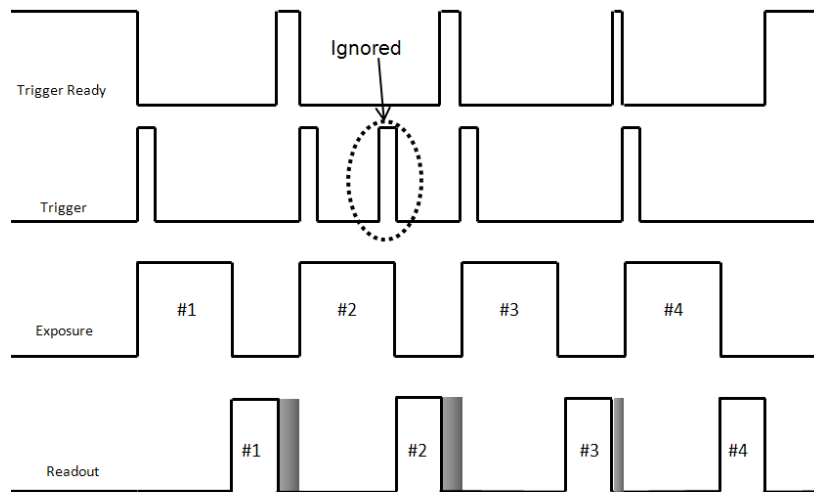



Figure 13. Strobe Mode Timing Diagram

Bulb Mode

In Bulb mode, exposure time for each frame is determined by the trigger pulse width. Exposure time entered into the software is ignored in this mode (see Figure 14). If a trigger arrives during the readout of the previous frame, it is ignored. The Trigger Ready signal goes high when Read-out has been completed. It then goes low when the Trigger signal is accepted and exposure is started. The shaded areas  denote the idle time between exposures. Bulb mode only operates in Non-Overlap mode.

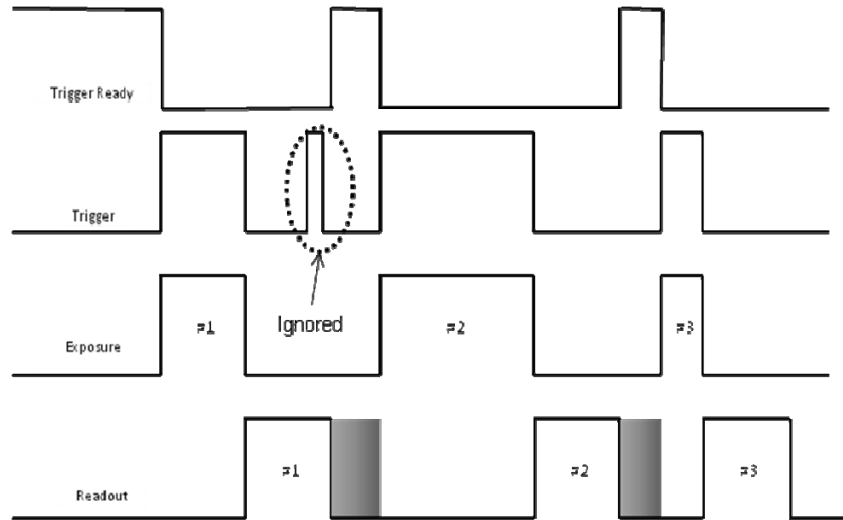

Figure 14. Bulb Mode Timing Diagram

Notes:

1. When the clocking mode is "Alternate Frame Transfer", the camera can be operated in "Overlap" or "Non-Overlap" mode as explained previously.
 2. Trigger-first mode allows overlap or non-overlap modes. In strobe and bulb triggering modes, the camera can be operated in non-overlap mode only.
-

Conversion Gain

Apart from multiplication gain, which actually multiplies the number of electrons generated in each pixel, the Evolve 512 also has three (3) conversion gains. Conversion gain simply quantifies how the resulting electrons are converted into ADU (Analog-to-Digital units) and displayed on the display screen.

Typical conversion gains for the readout port are listed later in this chapter. Your camera is individually calibrated for these gains. So, please refer to the certificate of performance that accompanied your camera.

Note: As the on-chip multiplication introduces additional noise, it is recommended that the multiplication be used only as required. For more information, refer to the "On-Chip Multiplication Gain" technical note. This technical note can be accessed by going to the Photometrics web site at www.photomet.com, clicking on "Library", clicking on "Technical Notes", and selecting the title from the list of notes.

Readout Speed (Typical)

Evolve 512 cameras are implemented with 10 MHz, 5MHz and 1.25 MHz digitization speeds (10 million, 5 million and 1.25 million pixels per second, respectively). At 10 MHz it gives approximately 31 frames per second (fps), whereas 1.25 MHz operation offers better image quality. With either digitizer, increased frame rate can be achieved by choosing a sub-region. For more information, please refer to the product data sheets.

The camera uses a frame-transfer CCD with a built-in storage (frame transfer) area, which makes simultaneous exposure and readout possible (Overlap mode) and which allows precise exposures to be set (Non-Overlap mode). These two readout modes are further explained in the "Exposure - Readout Modes" section in this chapter.

Binning

Binning (combining pixels into one super pixel) allows you to increase the sensitivity and frame rate. On the other hand, binning reduces spatial resolution. The Evolve 512 allows binning of 1, 2, 4, and 8 in the serial (horizontal) direction and 1 to 256 binning in the parallel direction.

Evolve 512 Features

Photometrics has developed several new industry-leading camera capabilities to streamline user workflow and enable researchers to concentrate directly on the image data that are important to their studies. These advanced functions enhance the quantitative nature of the camera while simultaneously allowing researchers to home in on the data they are looking for.

IMPORTANT NOTE: All of these features can be turned off in order to return to a standard-type setup for anyone who would rather use the camera in a more traditional way.

Advanced Evolve™ features include:

- Quant-View™
- Rapid-Cal™
- Background Event Reduction Technology™
- Black-Lock™ / Top-Lock™
- Vari-Bit™

This document contains a description of each of these features -- what they actually do and how they can be utilized by the research community to make their data much more quantitative.

Vari-Bit

This feature allows camera users to decide at which bit depth the digitization of the image should occur. Often with EMCCD imaging in biology, the intrascene dynamic range does not justify the use of high-bit-depth digitization (e.g., 16 bits) and the resultant image contains gray levels that represent fractions of photoelectrons. With this advanced feature, users can determine and select a more relevant digitization bit depth for their experiments.

How will it help?

By matching the digitization bit depth more closely to the actual intrascene dynamic range, the image quality will improve. Actual transitions between light levels from pixel to pixel will appear sharper to the eye; subsequently, users will be more certain of the results they are seeing. Using higher-bit-depth digitization does not make measurements less quantitative when measuring a scene with a low dynamic range; however, it does introduce many extra (or unnecessary) gray levels that do not represent actual physical photons.



Figure 15. Benefit of Vari-bit

Quant-View

A CCD counts photons by generating electrons when incident photons hit the device's array. These electrons are counted and converted into an analog-to-digital unit (ADU) value. High-performance camera companies such as Photometrics provide users the system gain number (expressed as electrons per ADU) for each of their cameras, enabling them to convert the ADU value back into actual electrons.

The new Quant-View feature performs this conversion for users in real-time. The camera reads out the pixel values in electrons measured. This number, along with the exposure time, can then be used to calculate the number of electrons generated at any pixel per unit measure of time – effectively providing an electron flux measurement.

Electrons-per-gray-level selector

This allows users to select how many electrons will cause a single gray-level increase in the image data. If there are enough photons to saturate the 16-bit data bus but there is still no saturation of the physical pixel of the EMCCD, then users can raise the number of electrons needed to increase the gray level to the next value.

For example, if you have 1000 electrons, then you are able to decide if this should be represented by 1000 gray levels (1 electron per gray level selected), by 500 gray levels (2 electrons per gray level selected), or by 250 gray levels (4 electrons per gray level selected).

This enables users to utilize Quant-View while maintaining the entire dynamic range of the EMCCD. The camera's highest bit depth in this quantitative mode is 16 bits. This means that as many as 65,535 gray levels per pixel can be sent over the bus. However, for the CCD97 used in the Evolve 512 camera, the total number of electrons possible in a single pixel can easily reach 200,000. Thus, if the camera was set at 1 electron per gray level, then the pixel would come across as saturated (it would max out at the 65,535 value). So, by selecting each gray level to be equivalent to 4 electrons, the camera will send over a value of 50,000 gray levels, which is equivalent to 200,000 electrons. This feature is part of the Quant-View feature, ensuring that users are able to utilize the full capability of the EMCCD while remaining in Quant-View mode.

How will Quant-View help?

By actually measuring the electrons generated, users quantitatively know what the image is measuring in actual electrons. There are many examples where such data will be important for bio-research. One example would be when normalizing for transfection levels. Often, fluorescent proteins are transfected at different levels and results are taken and measured. These results are often just reported relative to “control cells”. Utilizing Quant-View measurements will enable researchers to discern if they are looking at cells that are transfected to similar levels, day to day and even year to year. Over-expression artifacts and results could be identified in this manner, leading to higher-quality research.

Quant-View in action

For further explanation, including a real-time demonstration of Quant-View, please visit www.evolve-emccd.com

Rapid-Cal

Calibration

The Evolve 512 has incorporated a calibration routine which allows the camera to adjust voltages of the ADC offsets such that the electron multiplication gain input given to the camera reflects the actual gain provided by the device. Settings 1 to 1000 on the electron multiplication gain slider are mapped linearly to provide the actual multiplication gain requested by the user. Due to the impact-ionization method used with the electron-multiplication gain register the actual gain realized by the detector with time will slowly be reduced. By using the calibration routine the camera is able to re-establish the electron multiplication gain slider such that it will provide the gain which is input on the gain slider. This ensures the quantitative nature of the camera over time. Even though the camera is capable of delivering large multiplication gain factors, multiplication gain should only be used as needed to preserve as much dynamic range as necessary and to prolong the device's lifetime.

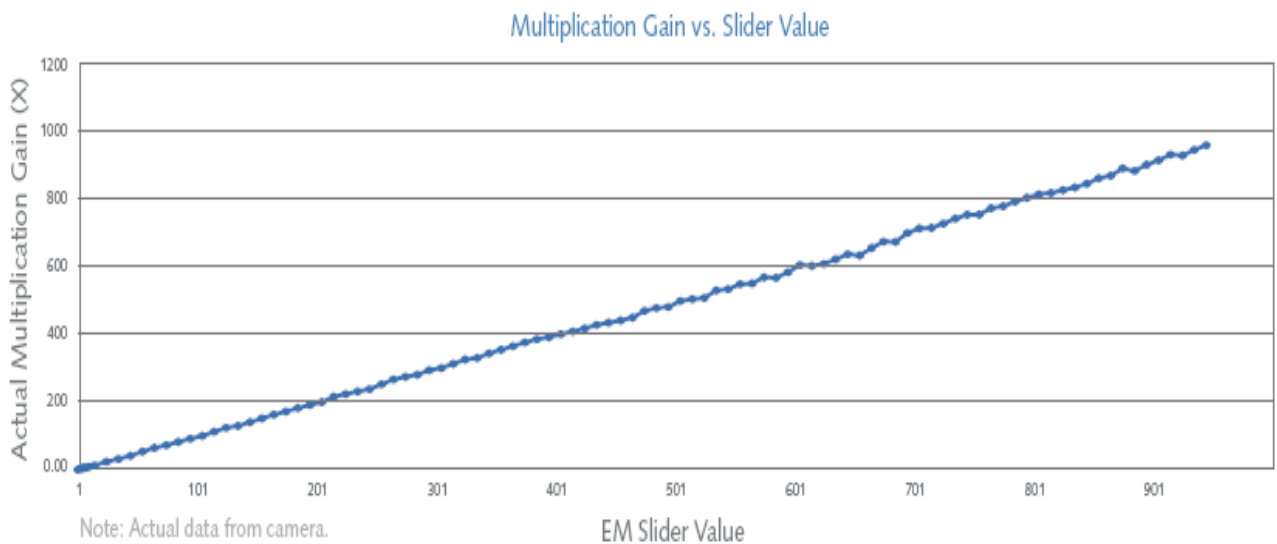

Figure 16. DAC Setting vs. Charge Multiplication Gain for Evolve 512

EMCCD cameras are subject to aging of the EMCCD register as a result of its usage. The Evolve 512 has a simple calibration feature that performs the industry's most accurate EM calibration within 3 minutes. A simple turn of the camera's nose-piece closes a shutter and activates a light source which the detector uses to calibrate its EM gain. This ensures that users will receive the most accurate electron multiplication and the EM gain applied matches what the user requests. Simple software control will allow the user to use this feature as a manual shutter in order to block all light from the sensor in order to take dark reference frames if necessary.

How will Rapid-Cal help?

It is a necessary requirement that your electron multiplication be accurate if you wish to be quantitative the images taken by an EMCCD camera. The Evolve camera's Rapid-Cal allows extremely accurate and rapid calibration of the EM-Gain ensuring your data can be quantitative all of the time. It is recommended that calibration be performed once a week although the requirements of calibration will vary depending on the usage of the camera.

Rapid-Cal in action

LED INDICATOR	FUNCTION
OFF	Calibrator off
FLASHING AMBER/ORANGE	Calibration waiting for CCD temperature lock in order to proceed
FLASHING GREEN	Calibrating
SOLID GREEN	Calibration complete
RED	Error

Figure 17. RapidCal Status

For further explanation, including a real-time demonstration of Rapid-Cal, please visit www.evolve-emccd.com

Background Event Reduction Technology

EMCCD cameras are actually capable of detecting single photons. However, the real detection limit of these cameras is set by the number of background events. These can arise from two things, Dark-current (which is thermal generation of an electron and is a temperature-dependent phenomenon) and also clock induced charge (CIC) electrons (also called spurious charge). Each can lead to the generation of non-photon derived electrons which are multiplied through the electron-multiplication register generating random high value pixels which are above the read noise. These are often referred to as “speckles” in the image. Photometrics has developed this real-time feature to help users identify such events and correct for them, in their images in real-time.

Users can set a threshold parameter that will measure the variation of a pixel value from all of its neighboring pixels and if the pixel value is unusually large such that it cannot come from real light through the microscope then the evolve camera will realign the pixel value to a best approximation of where it should be – all in real-time. This serves to absolutely minimize the influence of clock induced charge and thermally induced amplified events on acquired data.

How will background event reduction help?

This technology will help reduce the EMCCD induced artifact of spurious noise from entering your acquired data. Some may see this as a processing feature and claim that data is being altered. It is important to note that this feature (like all others) is completely controlled by the user and can be switched on or off. It should also be noted that the camera’s major task is to most accurately represent the sample it is imaging. If the technology components used in the camera can cause the introduction of artifacts in the image then utilizing technology to minimize the influence of such artifacts is also just an extension of good technology design. The BERT function is an example of additional technology being used to enable the camera to more accurately represent the data being acquired.

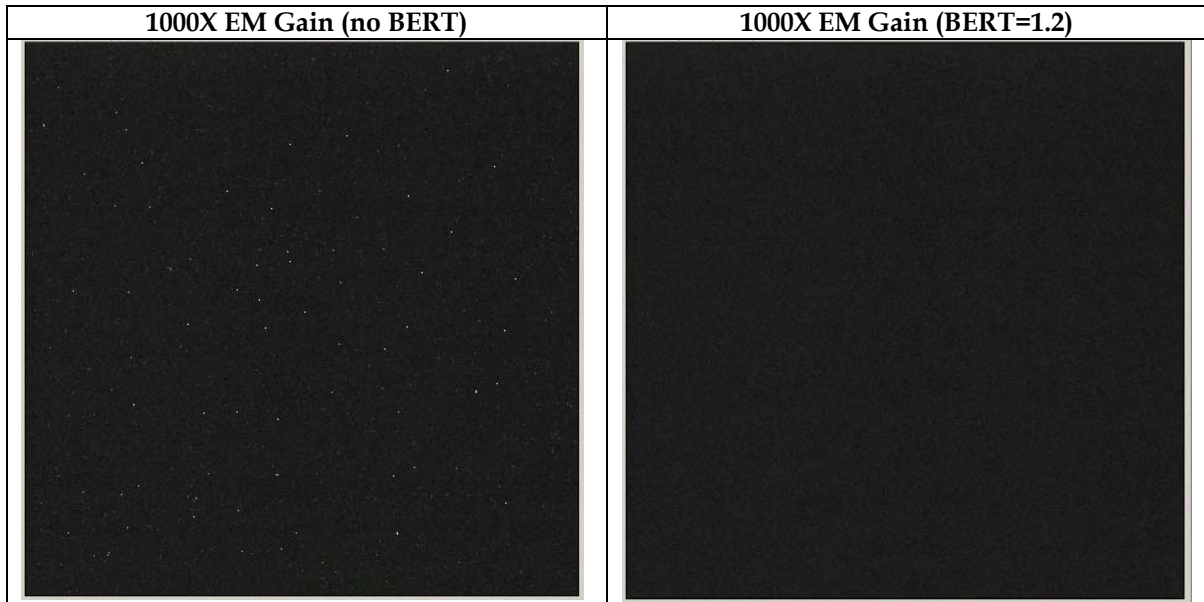

Figure 18. BERT Off vs BERT On

Background event reduction in action

For further explanation, including a demonstration of background event reduction technology please visit www.evolve-emccd.com

Black-Lock/Top-Lock

Black-Lock

This advanced feature effectively functions as an intensity filter for the camera. It allows users to select the background level at which the EMCCD will make all pixels at or below the selected value equal to the value selected.

How will it help?

This advanced feature allows users to define an effective floor for an image at a level which they select. In the case of the Evolve 512, many users operate the camera in EM gain mode and apply EM gain at high levels. In such scenarios, EMCCD cameras can end up having multiple ADUs per electron. Traditional CCDs are set up to have electrons per ADU, which makes sense, as you can take the ADU measurement and convert it back to electrons. However, in the case of an EMCCD when EM gain is applied, the actual gain can increase such that you will end up with multiple ADUs being equivalent to a single electron.

For example, a traditional EMCCD camera with 3 electrons per ADU and 300x EM gain applied actually has 0.01 electrons per ADU. Thus, 100 ADUs is equivalent to a single electron of signal. For most bio-researchers, any signal less than 1 electron (equivalent to a single photon in a 100% QE system) does not represent meaningful data.

With the Black-Lock feature from Photometrics, users can select at which point this value should be set. For instance, in the above example, one could set the Black Lock at 75 ADU above the image bias. As a result, the camera will read all pixels at or below 75 ADU as 75 ADU. Effectively, users are able to set the floor of the image and determine at which intensity levels data will be collected.

Top-Lock

This advanced feature effectively functions as an intensity filter for the camera. It allows users to select the background level at which the EMCCD will make all pixels at or above the selected value equal to the value selected.

How will it help?

This advanced feature allows users to define an effective roof for an image at a level which they select. In many experimental conditions, there may be intense objects in the field of view that are actually of little or no interest to the experimenter. A simple example may be a piece of debris in the field of view that happens to be highly fluorescently labeled. If the debris is not of interest, a top intensity value of the image can be selected so that every single pixel in the image at or above the selected top intensity value will be displayed as the selected top value.

Another example where Top-Lock may be important is when researchers are looking for small, low-intensity-labeled features that are actually budding off or being released from a large feature. A specific example would be something like small vesicles being released from the Golgi apparatus in a cell. If the researcher is only interested in observing and tracking these features but the highly labeled Golgi is swamping the image display, then the camera can be set to lock all intensities above a certain level to that level. This will make the features the researcher is interested in much more visible, as well as scaled nicely within the display image for ready visualization.

Combining Black-Lock and Top-Lock

Utilizing Top-Lock and Black-Lock together allows users to narrow visualization rapidly and effectively into the intensity range of the image features they are most interested in.

Black-lock and Top-lock in action

For further explanation, including a real-time demonstration of black-lock and top-lock, please visit www.evolve-emccd.com

Dual-Readout Port Operation

The Evolve 512 is configured with software-selectable dual-readout amplifiers, also referred to as "ports", shown in the next figure. The two amplifiers are listed below.

Port #1: On-chip Multiplication amplifier

Port #2: Traditional or non-multiplication amplifier

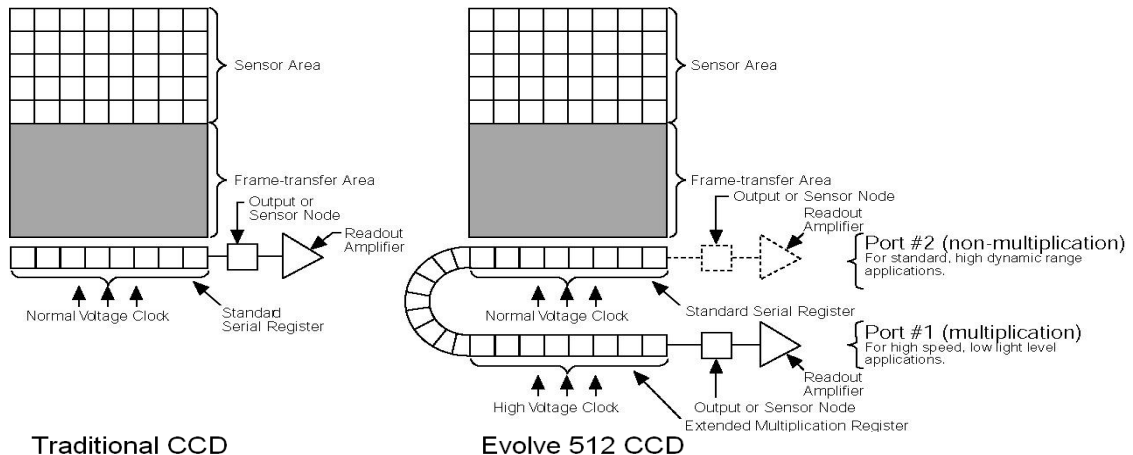

Figure 19. Evolve 512 CCD Array Structure

The software allows port selection. An example of a software dialogue to select the ports is shown in the next figure.

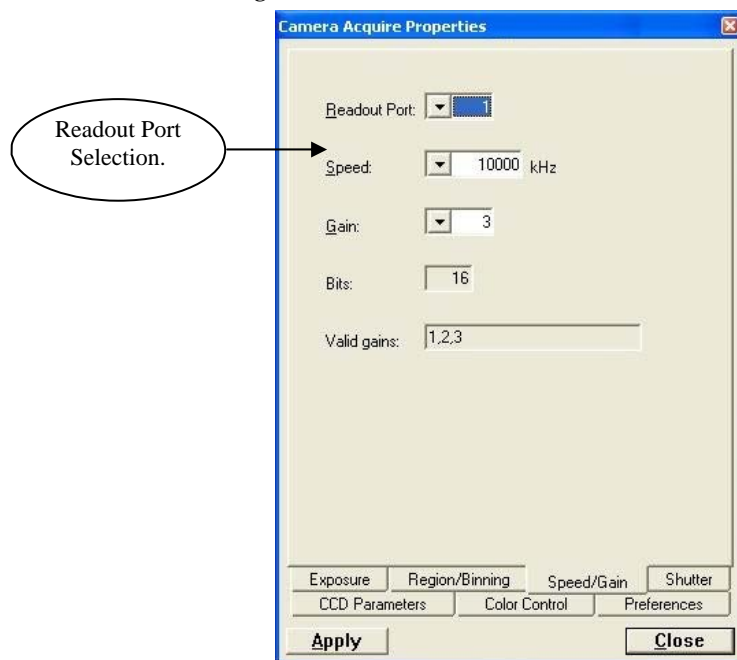

Figure 20. Software Selection of Readout Port

Note: As the user interface may be different, please refer to your software manual for specific information on readout amplifier/port selection.

On-Chip Multiplication Amplifier (Port #1): Operation of multiplication gain in the Evolve 512 is different from the previous generation of these cameras. The new “Evolve” generation of cameras have new functionality that was not available on previous models. A setting of 0 (zero) results in unity gain and the subsequent settings are linearly related to the actual multiplication gain. Since the multiplication gain can be used to overcome the read noise of the fast amplifier, this mode is most useful in applications requiring low-light sensitivity at high frame rates (e.g., Single molecule fluorescence, ion imaging, etc.).

Note: When used with a standard lens, Port #1 (multiplication port) produces an image in the correct orientation. The first pixel is read out at the bottom left of the array.

Traditional or Non-Multiplication amplifier (Port #2): When the camera is using this amplifier, electrons (signal) generated in pixels are clocked through the standard serial register. The amplifier is designed to take advantage of the dynamic range of the CCD and is most useful when the frame rate is not critical, (e.g., bright field, fixed cell fluorescence, etc.).

Note: Since the first pixel to be read out from Port #2 is at the bottom right (closest to the Port #2), the resulting image is a mirror image of the same image if it were read out of Port #1. Some software packages do a "horizontal-flip" in the software when Port #2 is selected to ensure the correct orientation for all ports. Please check your software documentation.

Conversion Gain

Apart from multiplication gain, which actually multiplies the number of electrons generated in each pixel, the Evolve 512 also has three (3) conversion gains. Conversion gain simply quantifies how the resulting electrons are converted into ADU (Analog-to-Digital units) and displayed on the display screen.

Typical conversion gains for different ports are listed in Table 1. Your camera is individually calibrated for these gains. So, please refer to the certificate of performance that accompanied your camera.

Readout Speed (typical)

The Evolve 512 has two readout speeds available on each of the two ports as listed in the table below:

Readout Amplifier (Port)	Readout Speeds	Conversion Gain (e ⁻ /ADU)
Port #1 (Multiplication)	5 MHz 10 MHz	#1: 12e ⁻ /ADU #2: 6e ⁻ /ADU #3: 3e ⁻ /ADU
Port #2 (Non-multiplication)	1.25 MHz 5 MHz	#1: 4e ⁻ /ADU #2: 2e ⁻ /ADU #3: 1e ⁻ /ADU

Table 1. Evolve 512 Readout Speeds and Typical Conversion Gains

A slower readout speed can be used when better noise performance is needed at the expense of frame rate. On the other hand, increased frame readout rate can be achieved by one or more of the following:

- higher readout speed,
- sub-region selection,
- binning.

For more information on frame rate, please refer to the product data sheet.

Binning

Binning (combining pixels into one super pixel) allows you to increase the sensitivity and frame rate. On the other hand, binning reduces spatial resolution. The Evolve 512 allows binning of 1, 2, 4 and 8 in the serial (horizontal) direction and binning in the parallel (vertical) direction, up to 256.

Note: Due to the small array size in the Evolve 512 edge artifacts may be present at higher binning.

Evolve 512 Application Examples

Example 1:

"I would like to obtain kinetic information (time-correlated) information of the single molecule fluorescence. My light level is fairly low and I want to optimize the frame rate of the camera."

For this application, the "Multiplication" port (Port #1) should be selected and camera speed should be set to 10 MHz. In addition, the camera should be operated in "Overlap mode". This can be achieved by setting the camera to "frame transfer mode" with clearing mode "Pre-sequence" and number of clears "1" (refer to Figure 8). If possible, choose a sub-region (ROI) and/or binning to further increase the frame rate. Finally, on-chip multiplication gain can be used to boost the signal level and achieve a high signal-to-noise ratio.

Example 2:

"My application requires precise control of the exposure time (less than the readout time) and I want to operate the camera in the most sensitive mode possible."

For better imaging characteristics, the "Multiplication" port (Port #1) is selected and camera speed must be set to 5 MHz. Use on-chip multiplication gain for increased sensitivity. To achieve an exposure time less than readout time, use Non-Overlap mode (shown in Figure 6) and set the clearing mode to "Pre-exposure" and clear count to "2".

Example 3:

"I would like to image a bright target/sample (e.g., fluorescence or bright field) that is fixed. High resolution and high dynamic range are important."

For imaging bright, non-moving samples, the "Non-multiplication" port (Port #2) offers the best performance in terms of dynamic range. Set the speed to 1.25 MHz (or 5 MHz, if higher speed is required) and conversion gain to #2 (this allows maximum full well of the CCD to be used). Reading out the full CCD (no-ROI or binning) gives best resolution possible. In addition, camera can be operated in overlap or non-overlap mode as explained before.

Application Settings Summary

The table below summarizes typical Evolve 512 settings for two types of applications and is provided as a setup aid. Actual settings will vary based on the exact nature of your experiment design.

Application	Readout Amplifier (Port)	Readout Speed	Multiplication Gain	Conversion Gain (e-/ADU)	Readout Mode
Kinetic samples (single molecule fluorescence or tracking)	Multiplication (Port #1)	10 MHz or 5 MHz	Use as required to obtain best signal-to-noise ratio (SNR). Typical EM gain values are around 200.	#2: 6e ⁻ /ADU	Overlap mode (Frame Transfer, Pre-Sequence)
Fixed samples (bright field)	Non-multiplication (Port #2)	1.25 MHz	Not Applicable	#1: 4e ⁻ /ADU	Overlap or Non-overlap

Table 2. Application Type and Evolve 512 Setup Parameters

Chapter 4

Troubleshooting

If you have any difficulty while troubleshooting, or do not see your camera system's symptoms listed here, contact Photometrics Customer Service.

System Does Not Boot Normally

If your operating system does not boot normally after you have installed an interface card, try installing the new card in another open PCI slot. If this does not work:

1. Turn off your computer and remove the newly installed interface card.
2. Turn your computer back on. If your system boots normally, there is probably an interrupt conflict between a previously installed expansion card and the interface card that you are installing.
3. If you need assistance resolving the interrupt conflict, contact Photometrics Customer Service.

New Hardware Found Dialog Box Does Not Appear (Windows 2000/XP)

If the New Hardware Found dialog box does not appear after installing a new interface card to your computer and booting Windows 2000/XP:

- Check to make sure that the new interface card is inserted in an expansion slot according to your computer manufacturer's instructions and that the Evolve 512 system's CD-ROM disc is in the host computer's CD drive.
- It is possible that there is a conflict between the new interface card and a previously installed expansion card. With the computer's power turned off, remove any previously installed expansion cards that your system does not need to function. (If you are unsure which cards can be safely removed, call Photometrics Customer Service.) Then turn your computer back on and boot Windows 2000/XP again.
- If the New Hardware Found dialog box still does not appear, contact Photometrics Customer Service.

Images Not Displayed

If no images appear:

- Confirm that the camera switch is set to on.
- Confirm that the Evolve 512 camera is selected in your imaging software application.
- Power off the camera and the host computer and check all system connections (particularly the DATA and power cables). Restart.
- Confirm that operating system is set for at least 64k colors (16 bits).
- Confirm that the camera is operational by taking an image with a standard C-mount lens attached to your Evolve 512. Using normal room lighting, place the camera on a table about 3 meters away from an object and acquire an image.

If the problem persists, contact Photometrics Customer Service.

Camera Running Too Warm

It is normal for the camera to be slightly warm to the touch while in operation. However, if the camera is more than slightly warm to the touch (and at least one inch of space has been left around the external cooling fins for airflow), switch off the camera immediately and contact Photometrics Customer Service.

PVCAM Error Message Appears

If a PVCAM error message appears, note the message's number code and contact Photometrics Customer Service.

Lengthy Pauses During Imaging

If you notice lengthy pauses marked by a lot of disk activity while imaging:

- Close any other programs that may be running.
- Install more physical memory (RAM) in your computer system.

Evolve 512 Will Not Image When Attached to Certain Dual-processor or Hyperthreading-capable PCs

Some high-end Windows 2000/XP-enabled computers with Intel Pentium or Xeon™ processors include a memory enhancement called Physical Address Extension (PAE). PAE allows these computers to address memory above 4GB; however, when PAE is enabled the IEEE-1394 Evolve 512 camera will not transmit any pixel data.

To determine whether your computer is running with PAE enabled, go to the Control Panel and open the "System" icon. Under the "General" tab, you will find a reference to Physical Address Extension in the "Computer" section.

To disable PAE, you must edit your C:\boot.ini file and remove the /PAE flag.

Chapter 5

Basic Specifications

Evolve 512

Front/Side Views

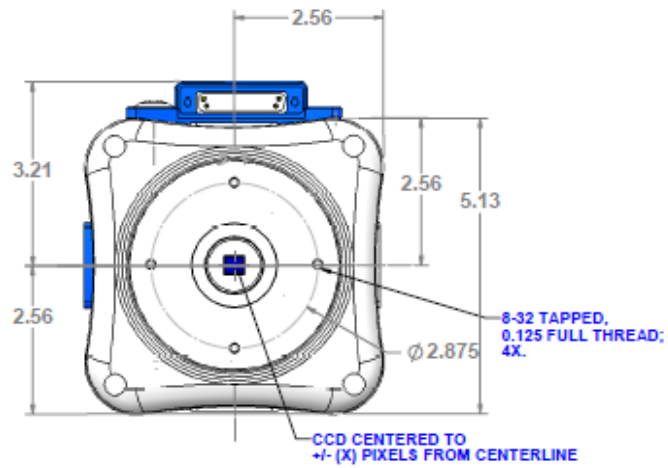

Figure 21. Evolve 512 Front View

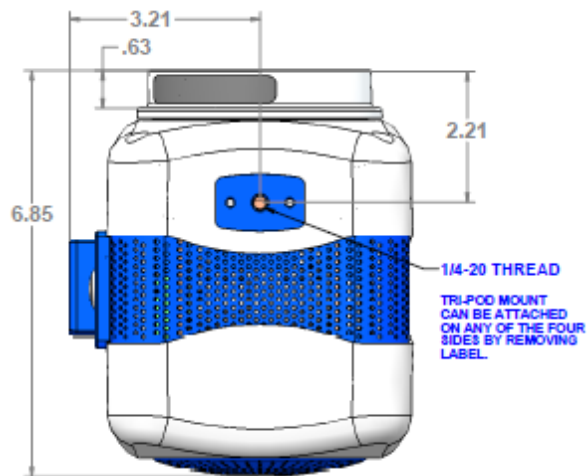

Figure 22. Evolve 512 Side View

Camera Weight

Weight: 6.5 lbs. (2.8 kg)

CCD Specifications

Window		UV grade fused-silica Broadband MgF ₂ anti-reflective coating on both surfaces
CCD Array		
	CCD	e2v CCD97-00
	CCD Process	Back Illuminated
	Resolution	512 x 512
	Pixel Size	16 μm x 16 μm
	Readout Amplifiers (Ports)	2
	Digitalization (Readout) Rate	10 MHz, 5 MHz, 1.25 MHz

Table 3. CCD Specifications

Connectors

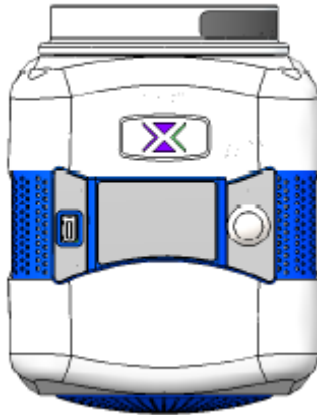



Figure 23. Evolve 512 Side Panel

The following connectors are located on the side of the camera.

-  **connector:** Type 1, 6 pin IEEE-1394a (FireWire).
- **POWER connector:** 25-pin, Dsub connector for camera power and I/O functions.

**Power Connector
Pinout:**

1. RX-IO
2. SHUTTER OUT
3. FPGA+5V
4. SPARE IO-1
5. /TRIG
6. /A PWR CONTROL
7. TEC-PWR
8. TEC-PWR
9. -15V
10. +37V
11. +3.3V
12. +3.3V
13. +16V
14. FPGA-GND
15. SPARE IO-2
16. EXPOSE
17. TX-IO
18. EOF
19. GND
20. TEC GND
21. TEC CONTROL
22. TEC GND
23. + 37V
24. GND
25. GND

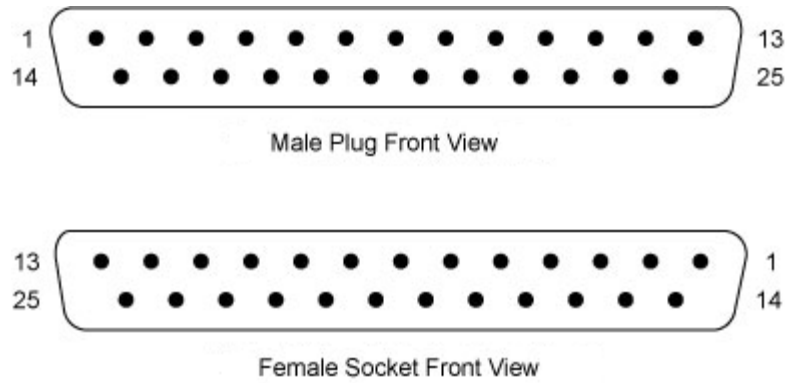

Figure 24. Power Connector Pinout

**I/O Connector
Pinout**

The I/O (Input/Output Status) connector located on the power supply provides TTL level trigger and status functions. Inputs must be at least 3.15 V for a high and less than 0.9 V for a low.

The numbers on the I/O connector diagram correspond to the numbers given to the definition of each of the pins. The I/O connector is a female, Hirose HR10A connector. An I/O cable (Part # 37-513-001) to access Trigger Input (Pin 1), Frame Readout (Pin 3), Camera exposing output (Pin 2), and Shutter Output (Pin 4) is available.

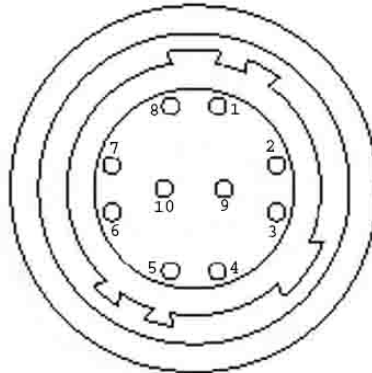

Figure 25. Input/Output Connector

INPUT/OUTPUT (I/O) TABLE		
#	I/O INPUT	DESCRIPTION
1	Trigger Input	This input is internally tied high through a 4.7kΩ resistor. A rising edge of the Trigger Input signal initiates the trigger. The trigger source would normally hold this input low and then drive it high to initiate the trigger.
2	Camera Exposing Output	Active high. A high level on this output indicates that the camera is exposing (integrating).
3	Frame Readout	Active high. A high level on this output indicates that data is being transferred.
4	Shutter Output	TTL output for timing of external shutter driver. Signal is high during Shutter Open Delay and exposure time. The pin does not provide power to drive the shutter directly, so an external shutter drive controller is required.
5	Spare Input	Reserved
6	Trigger Ready	This output notifies accessory devices that the camera is ready to receive a trigger.
7	TX Out	Accessory Serial Transmit
8	RX IN	Accessory Serial Receive
9	Power Status	A high level on this output indicates that the camera power is switched on (+5 V = on, 0 V = off).
10	GND	System digital ground. Any external circuitry intended to interface with the trigger control signals must reference this ground connection.

Table 4. Input/Output Definitions

Power Supply Specifications

Voltage Input: 100-240 V~ @ 50-60 Hz

Current Input: 2.0 A

Voltage Output: +3.6 V @ 1 A
+17 V @ 0.5 A
+37 V @ 0.2 A
-15 V @ 0.3 A
6-15 V @ 3.8 A

Maximum Power Output: 150 W

Power Supply Weight: 5 lb (2.267 kg)

Supply Cable Length: 6 ft. / 1.828 m

Note: CE certification applies to the Evolve 512 *only* when the camera system is operated with a CE-approved power supply



Figure 26. Power Supply Front

Appendix

Liquid Cooled Evolve: Setup Instructions

1. Unpack circulating chiller and insulated tubing assembly.
2. Confirm chiller and tubing are pre-filled with yellow-colored coolant. (Chiller is pre-set for 0C liquid temperature; consult chiller user manual to change setting.)
3. Align both disconnects on tubing into female disconnects on chiller. NOTE: The tubing assembly has two different sized boots on the ends. The end with the smaller diameter boot connects to the circulating chiller.
4. Press one connector into its mate on the chiller and twist 1/8 turn to lock.
5. Repeat with the second connector.
6. Slide the boot down over the collar surrounding the connectors on the chiller as far as it will go.
7. Secure around collar with zip-tie provided and repeat for other side of boot around hose insulation.
8. Unpack camera head, power supply, PCI card and interface cable.
9. Inspect components and set-up according to quick-start guide for Evolve.
DO NOT power on camera.
10. Slide large boot back along tubing to access connectors.
11. Press each on to its mating connector on the camera; listen for the “click”.
12. Pull each connector to ensure they are locked.
13. Return the boot to its original position and insert into the back of the camera as far as it will go.
14. Inspect the set-up to insure hoses are not pinched and boots are secure at chiller and camera.
15. Plug-in chiller and turn on.
16. Open cap on top of chiller when running to observe liquid level and confirm circulation. (Liquid surface will appear agitated with normal circulation.)
17. Turn on camera power and continue setup per quick-start guide. **NOTE: DO NOT turn-on camera power without liquid circulating!**
18. Open imaging software to set target temperature (-100C.)
19. Allow approximately 30 minutes to stabilize at target temperature.

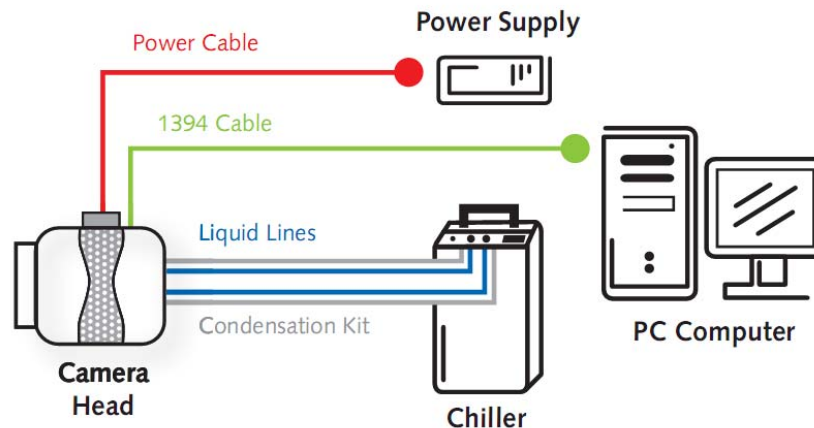

Figure 27. Liquid Cooled Evolve Setup Diagram

Index

B

Bias (Offset), 9
Binning, 17, 25
Bulb mode, 16

C

Cleaning
 exterior camera surfaces, 4
 imaging window, 4
C-mount, 8
 adjusting, 8
Computer (host), 6
Conversion gain, 24
Customer Service, ii

D

Data connector, 7, 30
Digitization speeds, 17

F

FireWire, 3, 5, 7

I

I/O connector, 7

L

Lenses, 4
Liquid Cooled, 34

M

Microscopes, 4
Multiplication
 gain, 1
 port, 16
 register, 1

N

Non-overlap readout mode, 10

O

On-chip multiplication gain, 9
Overlap readout mode, 12

P

Power connector, 7, 8, 30
Power Supply, 3, 5, 8, 33
Power switch, 7
Precautions, 3
PVCAM, 5, 6

R

Readout modes
 non-overlap, 10
 overlap, 12
Readout speed, 17
Repairs, 4

S

Saguaro software, 2, 5
Software, iii, 5
Specifications, 29
Strobe mode, 15
System components, 2

T

Trigger modes
 bulb, 16
 strobe, 15
 trigger-first, 14
Trigger-first mode, 14
Tripods, 4

W

Warranty, iii
 Your responsibility, iv

